

# Gravitational studies with Antihydrogen

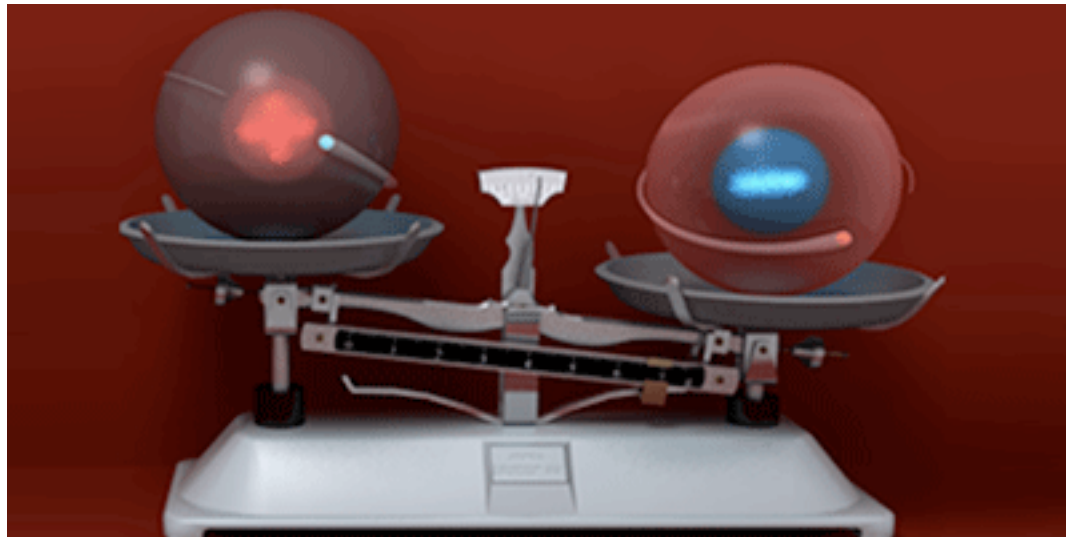

Dr. Will Bertsche

The University of Manchester  
The Cockcroft Institute



The University of Manchester



The Cockcroft Institute  
of Accelerator Science and Technology



# ALPHA Experiment @ CERN



- 18 institutions, ~60 members performing precision studies with trapped antihydrogen atoms at CERN





# What's the matter with Antimatter?

---

- Should be equal amounts produced at the beginning...

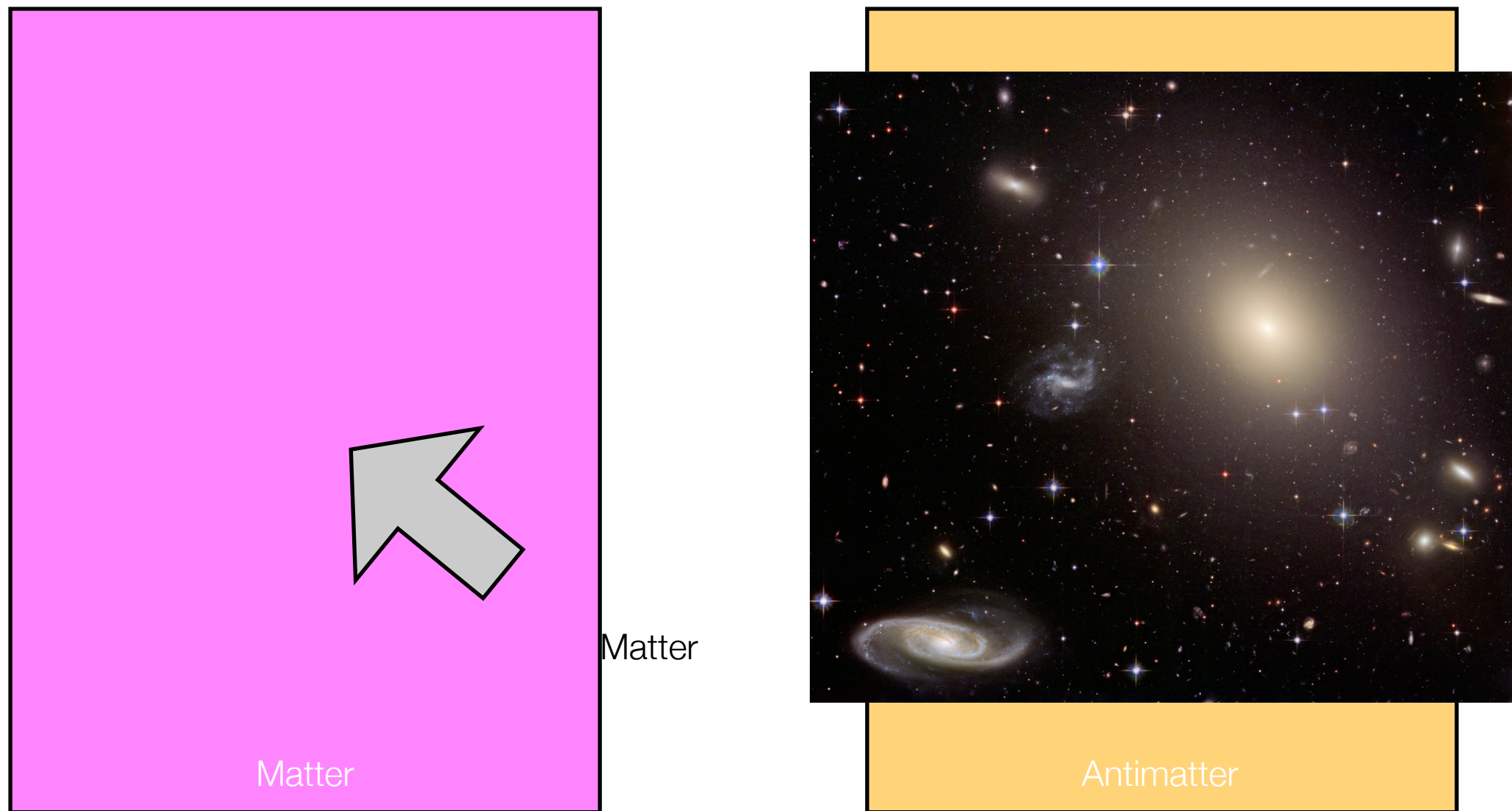

Matter

Antimatter

# Possible Explanations: Fundamental Flaw?

---

- C. P. T. Symmetry?
- Weak Equivalence Principal?
- Lorentz Invariance?
- Swap Matter for Antimatter: ***Uniquely Sensitive!***

# This talk: Free-Fall Weak Equivalence Principle

---

- Gravity?

Apple



Anti-Apple



Anti-Apple



Earth

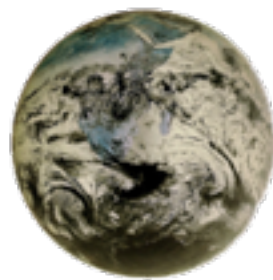

Anti-Earth



Earth

# Gravity and antimatter

---

- Prior experiments proposed to test antimatter investigated *charged* antimatter did not succeed
- Positrons and Antiprotons.
- Challenging because gravitation force so weak compared to forces from stray electric fields

$$\frac{m_e g}{e} \sim 10^{-11} \text{ V/m}$$

# Gravity and antimatter: Fairbanks Experiment

- Electron test for a positron experiment
- Pulse electrons with a low velocity into a shielded drift tube
- Measure drift time  $t$  over length  $L$
- *Infer gravitational acceleration  $g$*

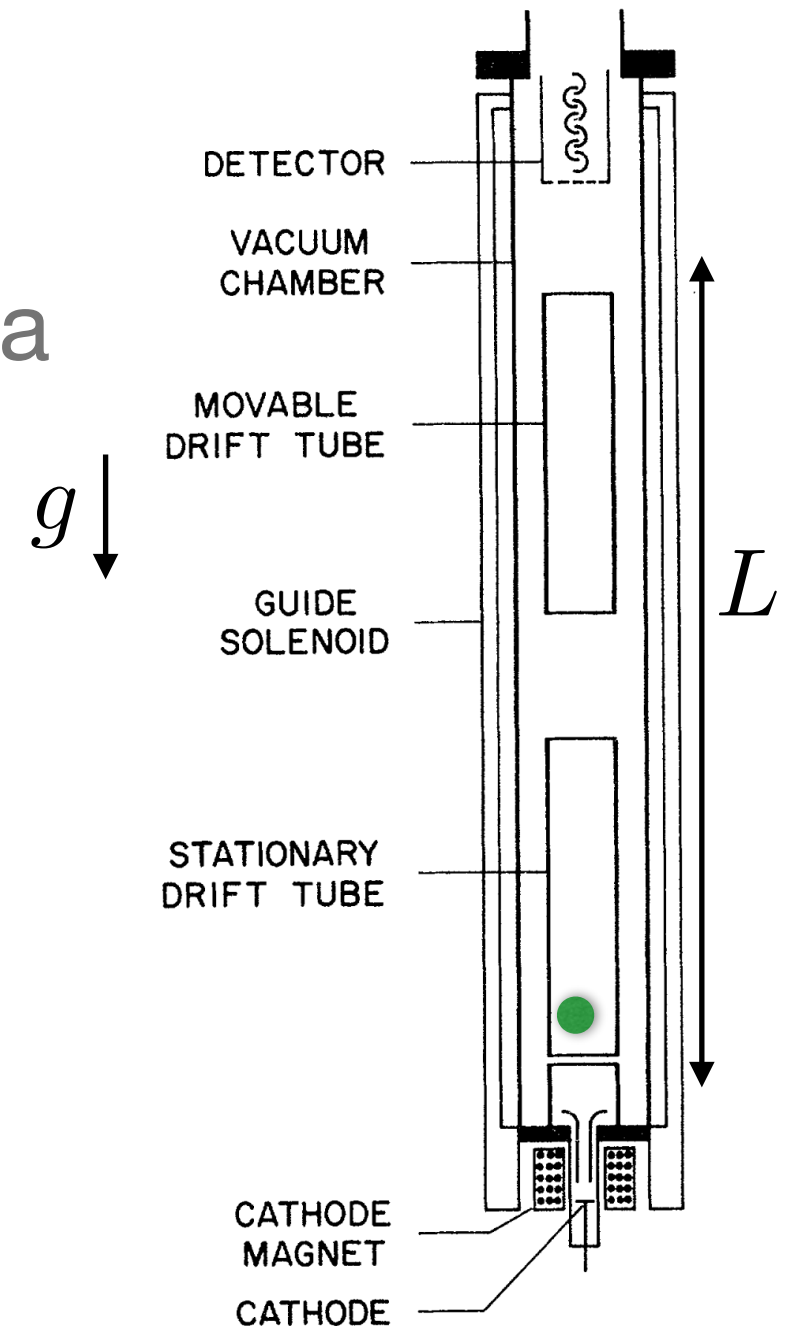

F. C. Witteborn and W. M. Fairbank, Experimental Comparison of the Gravitational Force on Freely Falling Electrons and Metallic Electrons, Phys. Rev. Lett. 19, 1049 (1967).

# Gravity and antimatter: Fairbanks Experiment

- Problem: Electrons sag in drift tube walls due to gravity

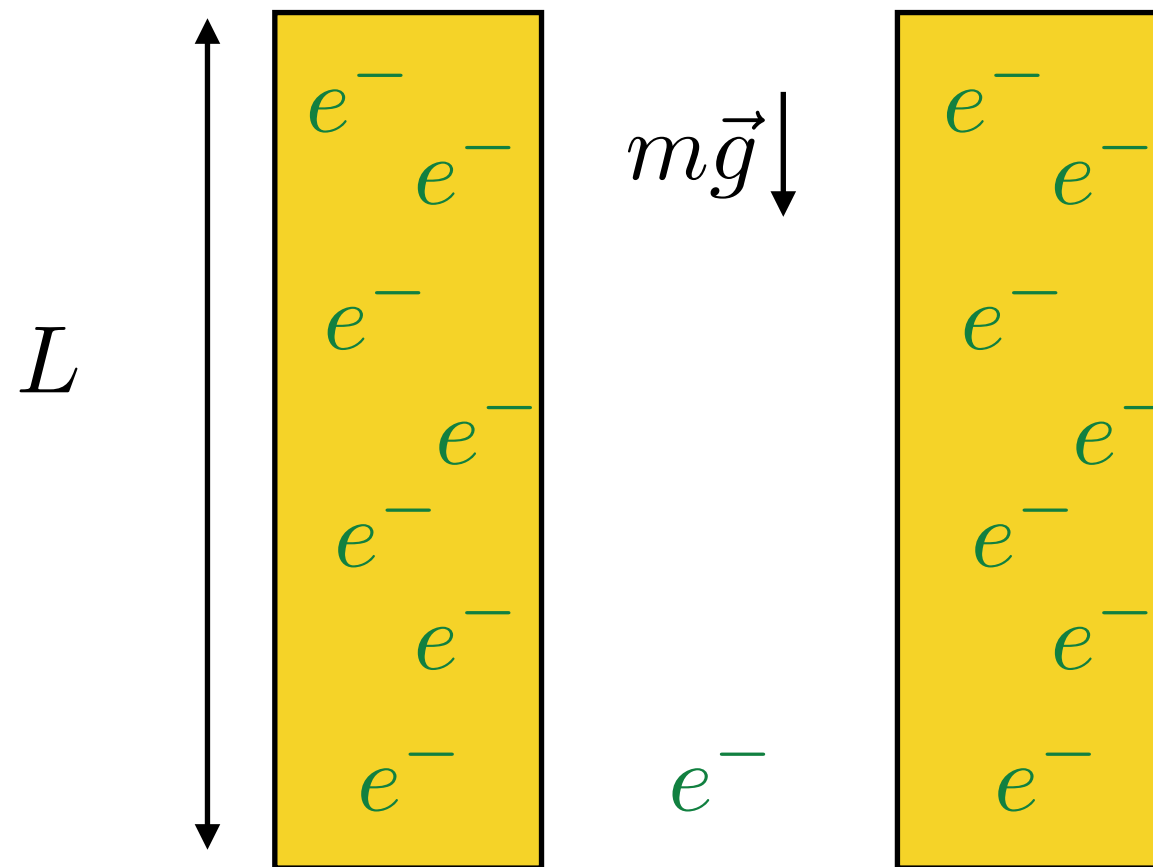

F. C. Witteborn and W. M. Fairbank, Experimental Comparison of the Gravitational Force on Freely Falling Electrons and Metallic Electrons, Phys. Rev. Lett. 19, 1049 (1967).



# Gravity and antimatter: Fairbanks Experiment

- Problem: Electrons sag in drift tube walls due to gravity

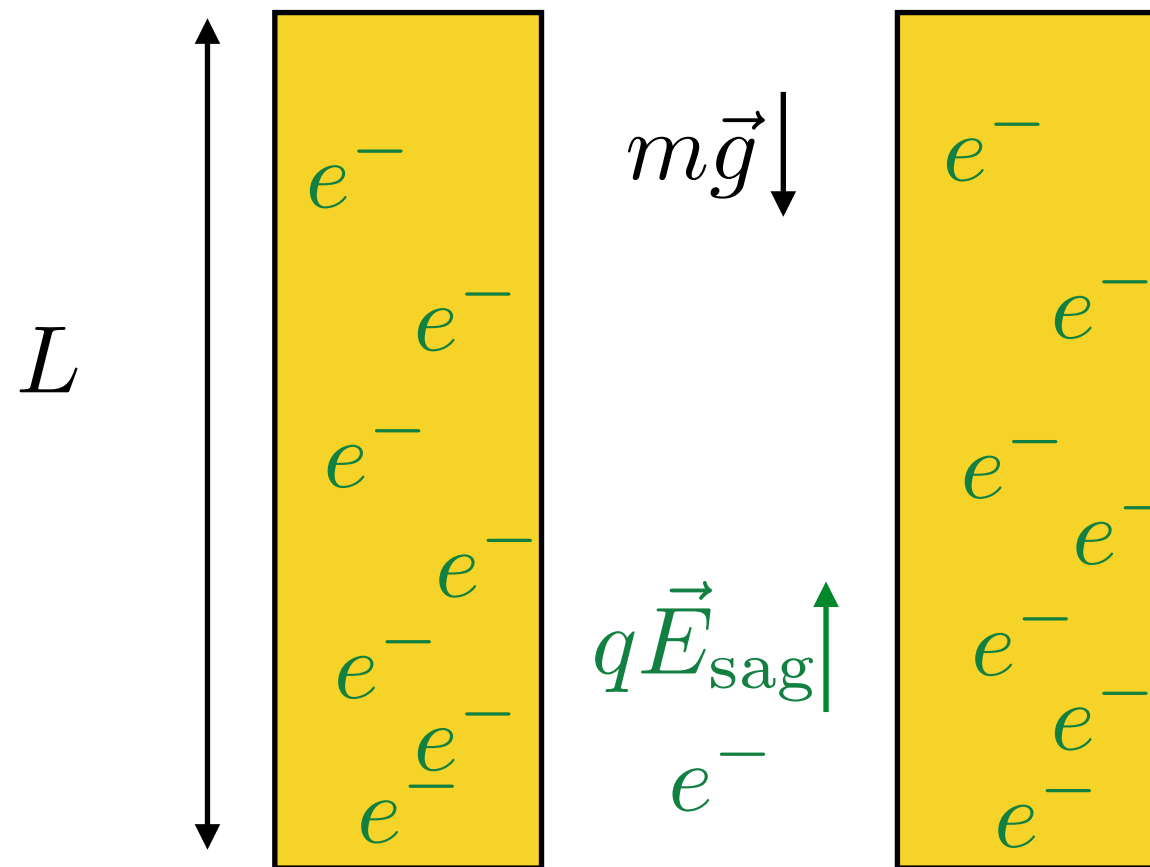

F. C. Witteborn and W. M. Fairbank, Experimental Comparison of the Gravitational Force on Freely Falling Electrons and Metallic Electrons, Phys. Rev. Lett. 19, 1049 (1967).

# Gravity and antimatter: Fairbanks Experiment

- Problem: Electrons sag in drift tube walls due to gravity
- Electrons practically did not accelerate!

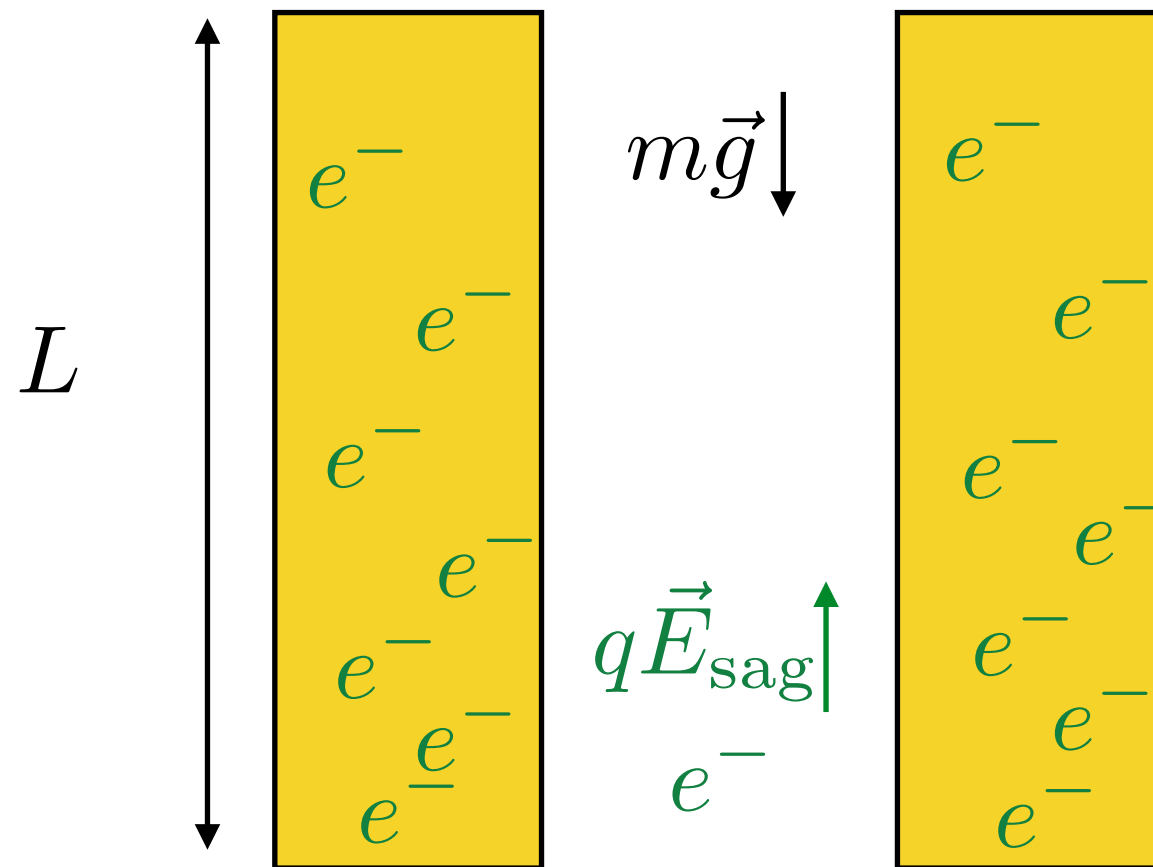

Schiff and MV. Barnhill, Gravitation-induced electric field near a metal, Phys. Rev. 151 (1966).

# Gravity and antimatter

- Numerous systematics with drift tube: ion sag (potentially worse, material, charge dependent)
- Fairbanks Experiment not repeated with positrons: Poor sources at the time
- PS200 - Antiproton experiment at CERN: Incomplete (LEAR shutdown)
- ***TO DATE: No gravity measurements on any charged particle***

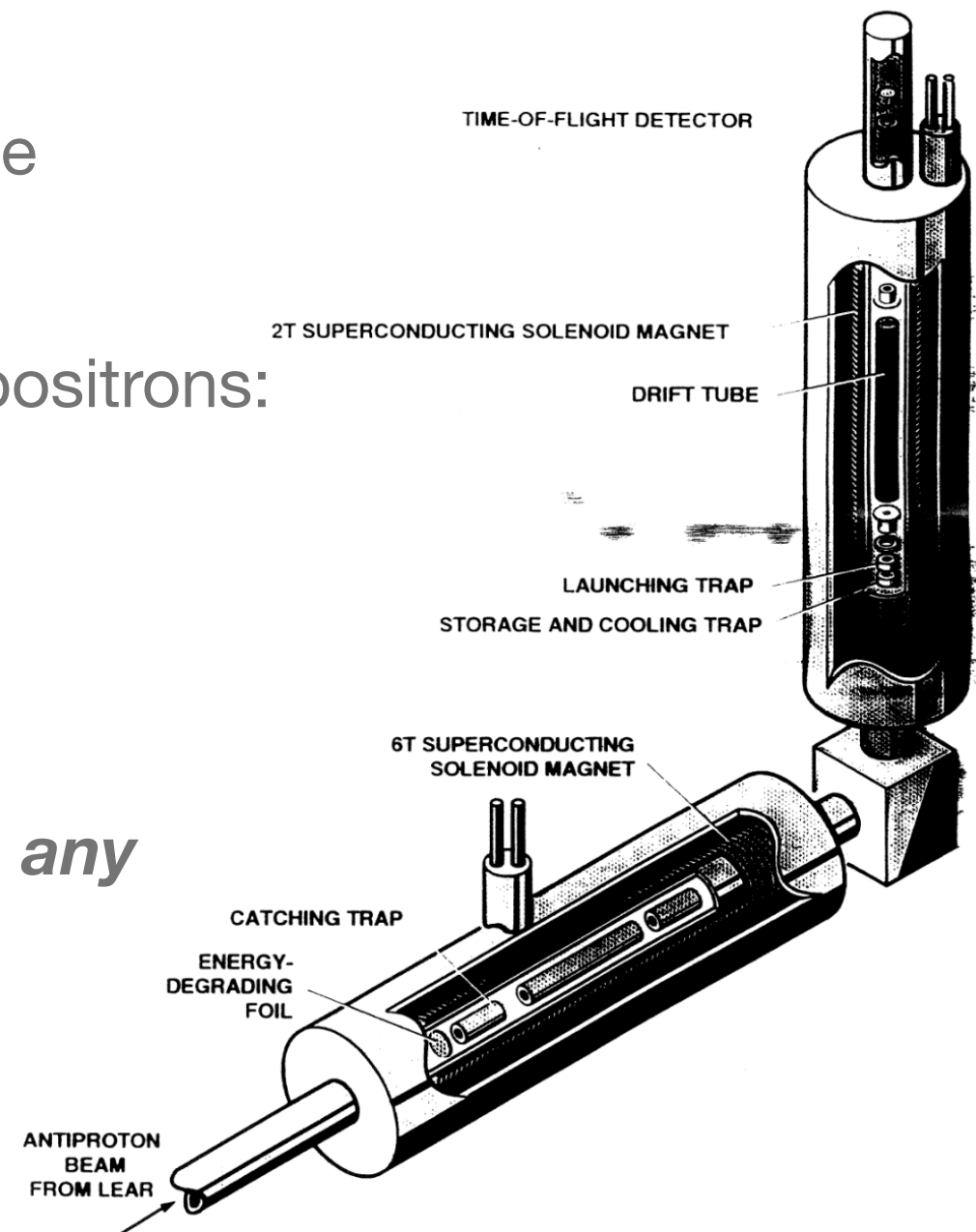

Fig. 1

A.J. Desser, F.C. Michel, H.E. Rorschach, G.T. Trammell, Gravitationally induced electric fields in conductors, Phys. Rev. 168 (1968).

PS 200 Collaboration Report: <http://cds.cern.ch/record/310553/files/cm-p00047643.pdf>

# Gravity and antimatter: Neutral efforts

---

- ALPHA (CERN): (trapped Hbar)



- Gbar (CERN): (Hbar fountain)



- AEgIS (CERN): (Hbar beam)



- LEMMING (PSI): Muonium



- Efforts with Positronium...

# Atoms and antimatter: Hydrogen and Antihydrogen

Matter:

Hydrogen

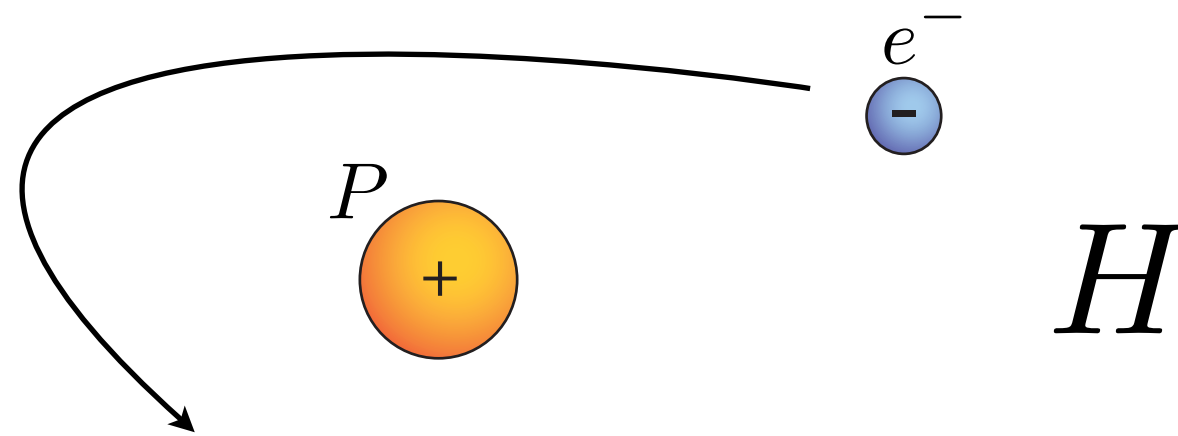

Antimatter:

Antihydrogen

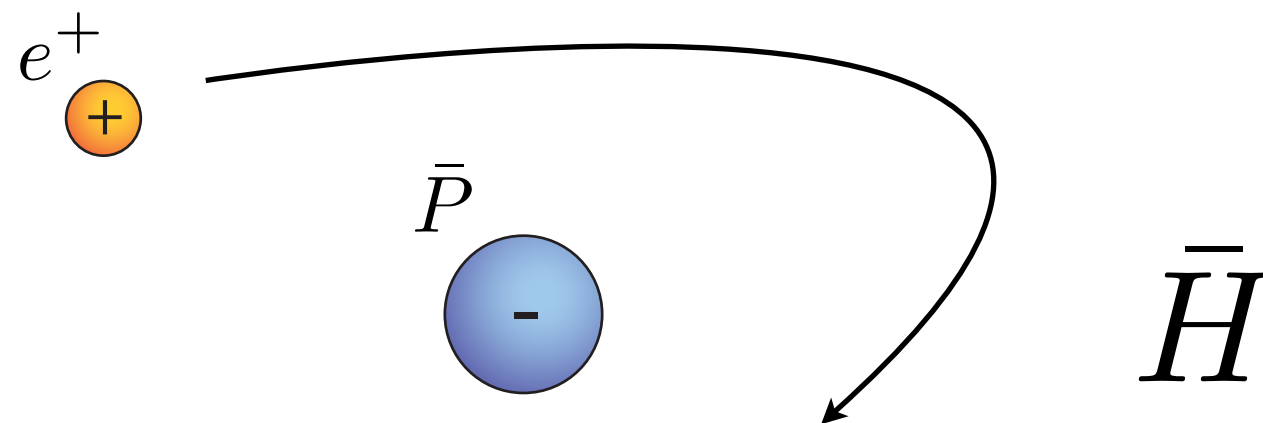

# Where do Positrons come from?

- Easy: Some radioactive isotopes

Banana Equivalent Dose (potassium):  
~ 15 positrons / second

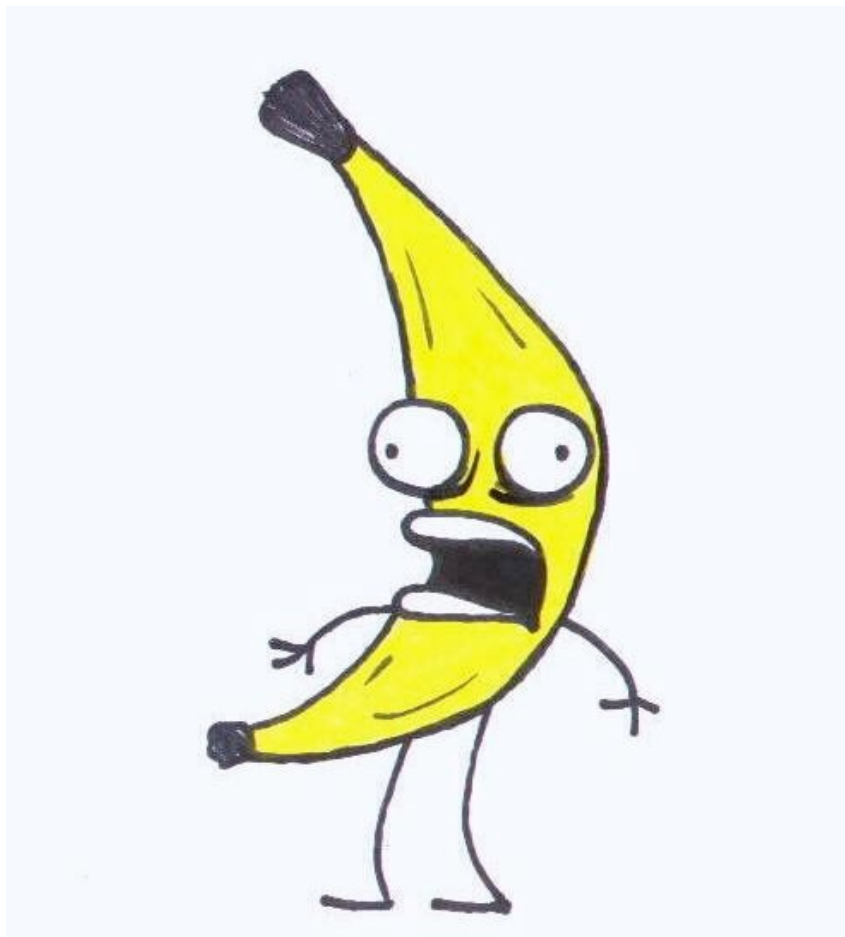
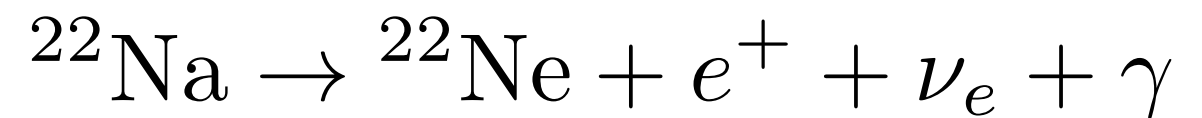

"I am a banana!" Don Hertzfeld





# Low energy antiprotons from CERN

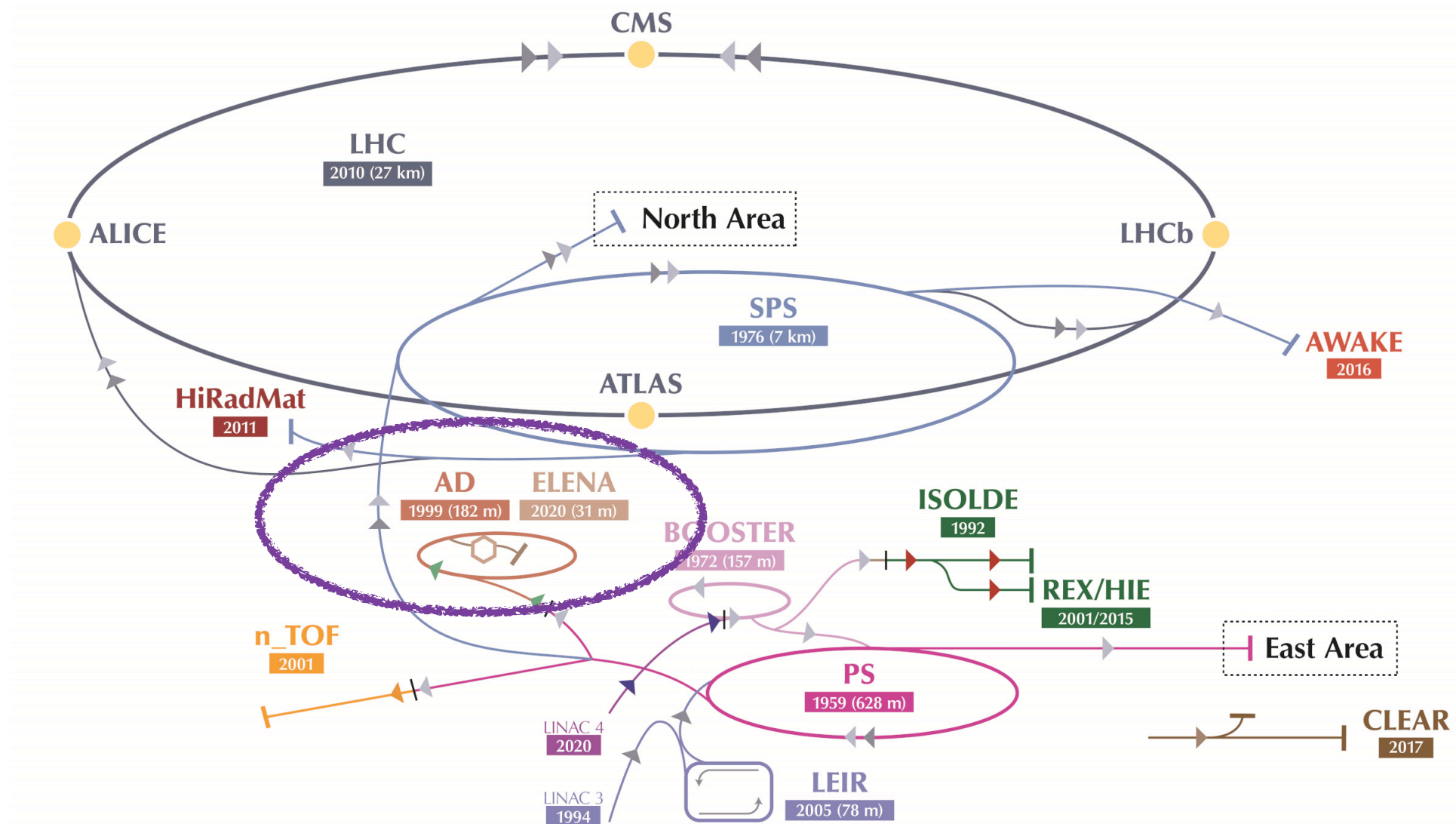

**~  $5 \times 10^6$  antiprotons per minute from ELENA, ~  $2 \times 10^5$  per minute in ALPHA**

# ALPHA as installed, 2022

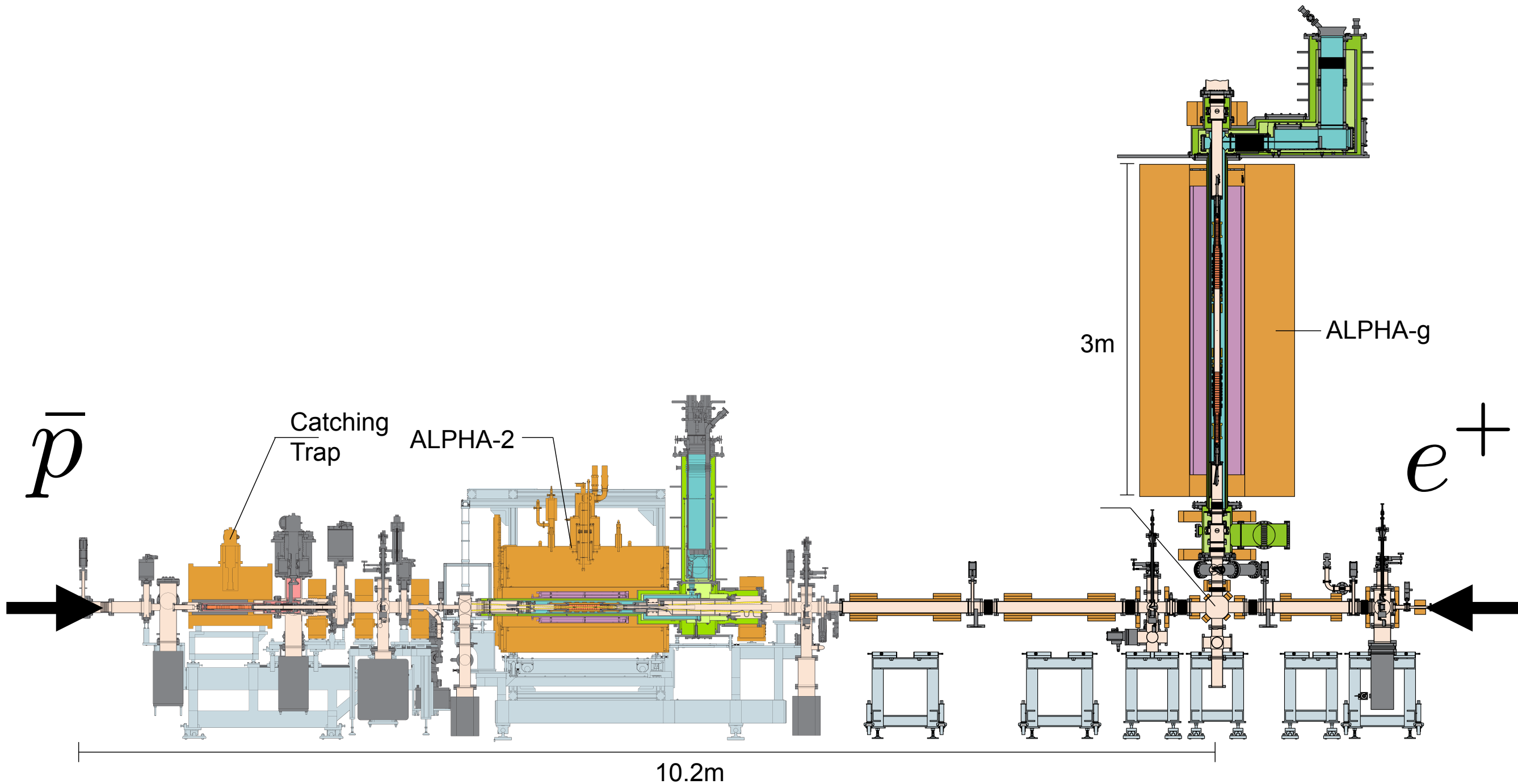

# Capturing Antiprotons in a Penning-Malmberg Trap

- Degrade antiprotons in Al Foil - 100 keV is still a lot...
- Trap  $\sim 200,000$  per bunch ( $< 5$  keV)
- Antiprotons sympathetically cool with electrons

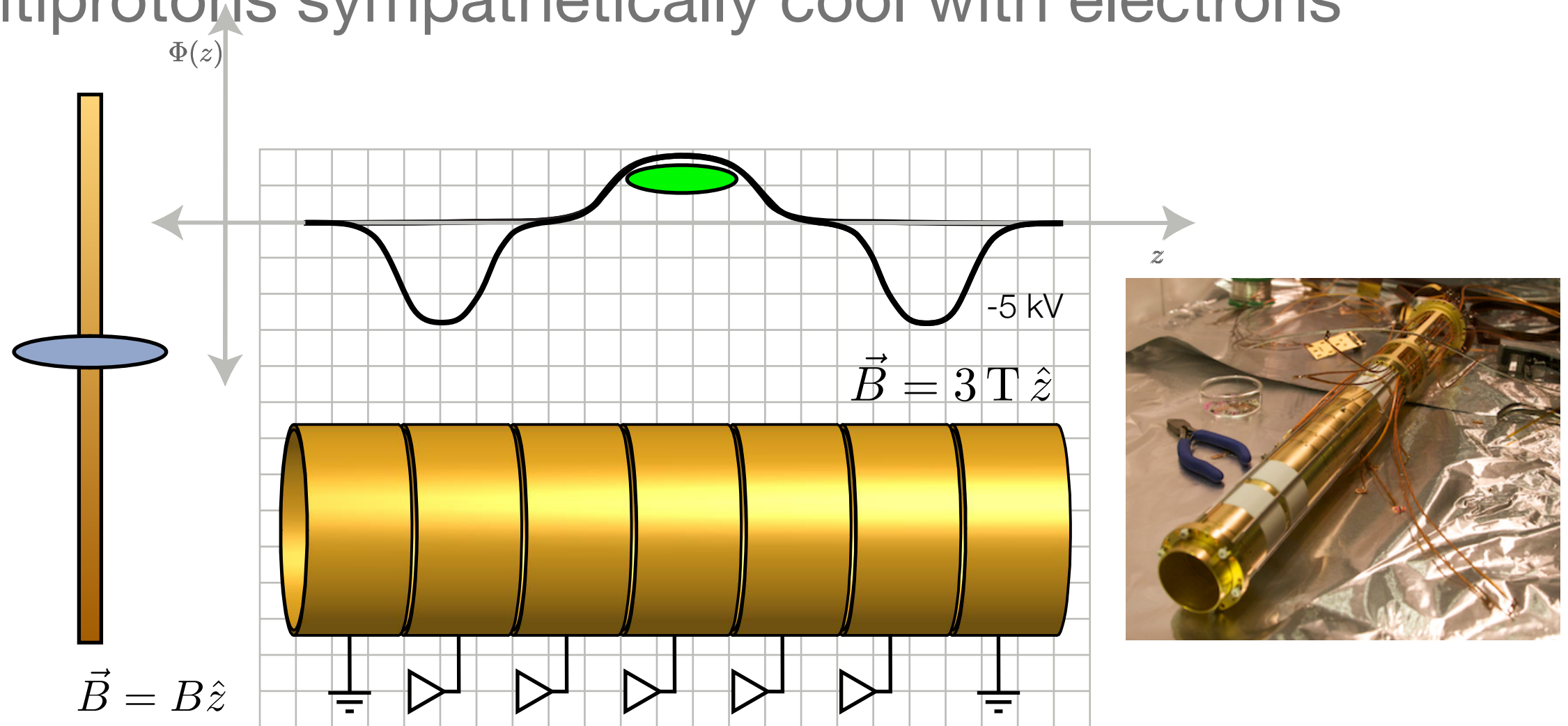

# Antiproton / Electron Plasma

---

- Image the equilibrium Antiproton / Electron plasma

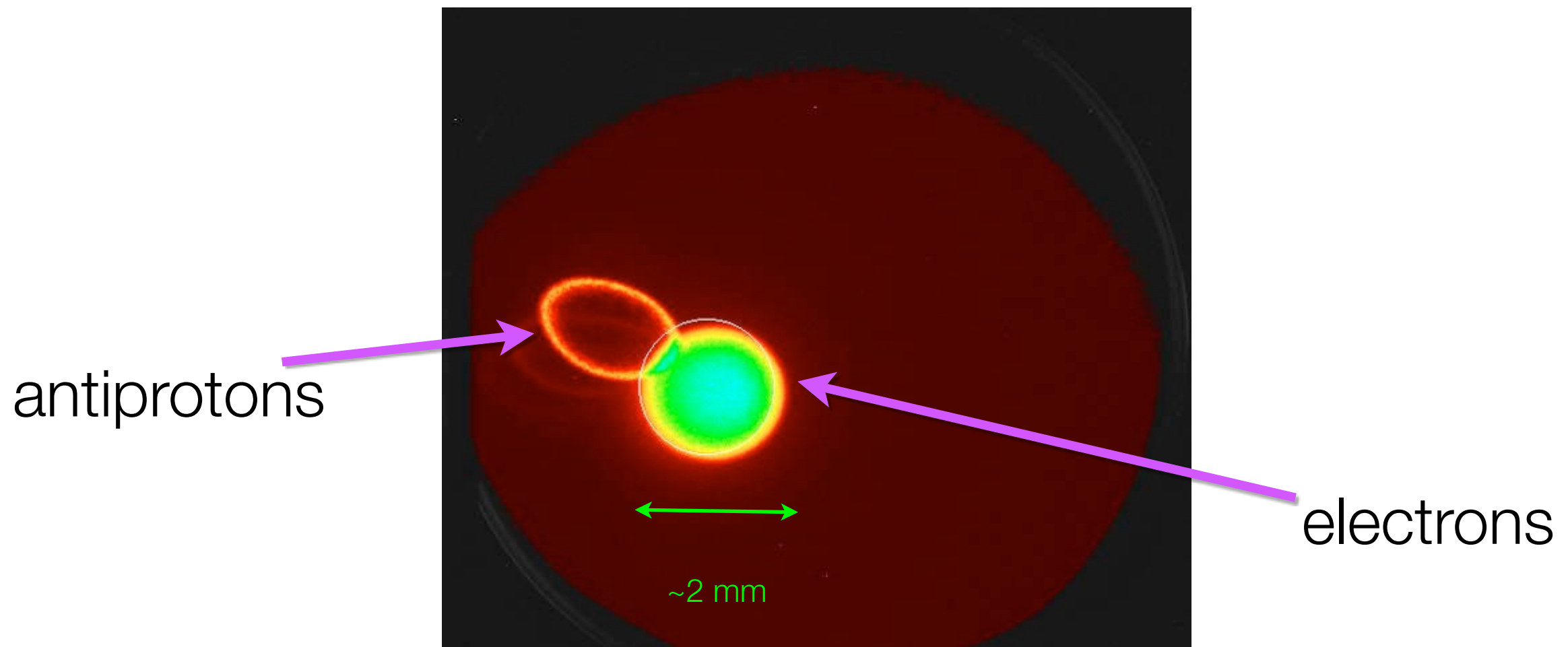

# Antihydrogen Formation: Mixing Antiprotons and Positrons

1. Merge Antiproton and Positron plasmas
2. Antiprotons and Positrons equilibrate and cool
3. Form Antihydrogen: atoms exit electrostatic trap

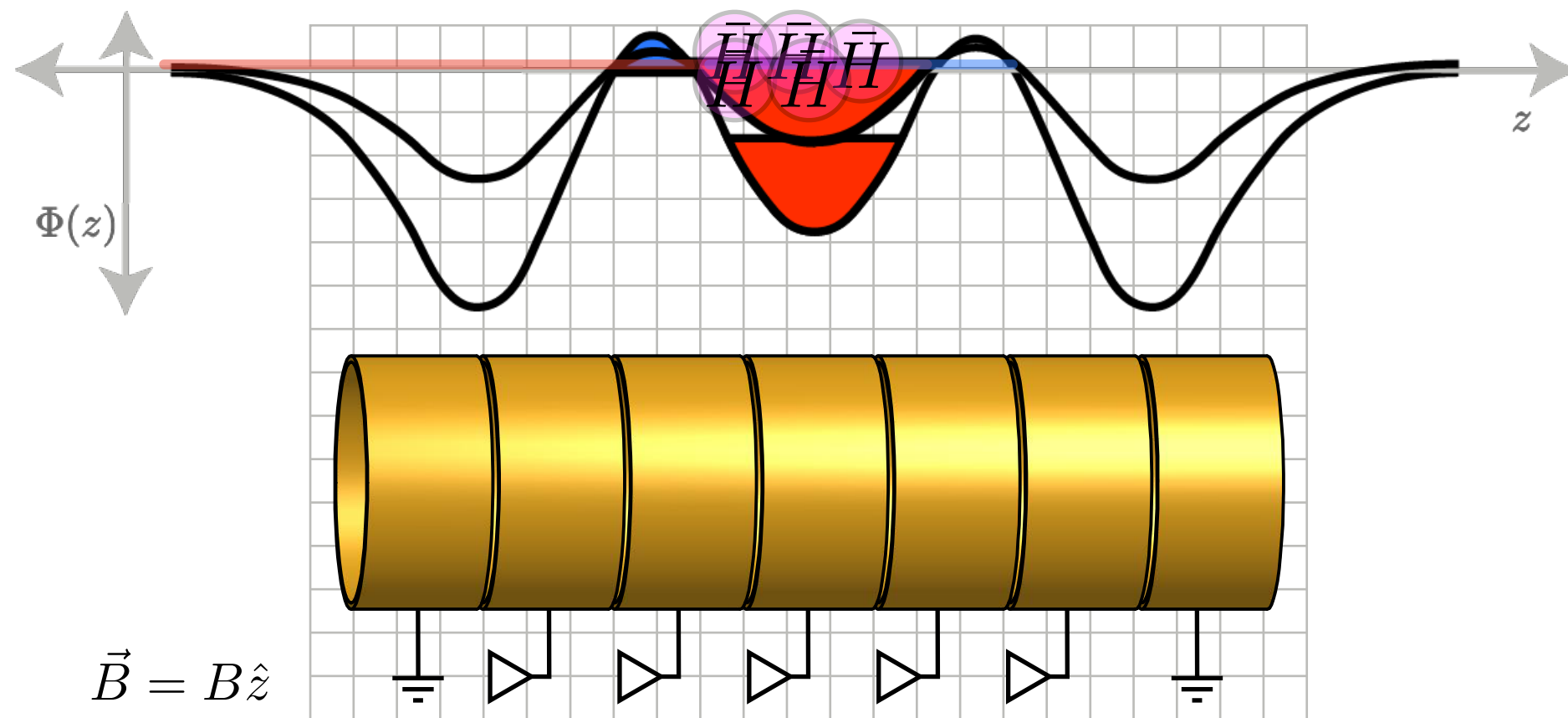



# Annihilation Detection: ALPHA-1, ALPHA-2

- Silicon-strip detector
- 3D 'Digital Camera'
- Vertex resolution  $\sim 6$  mm
- $> 70$  % efficiency for annihilations

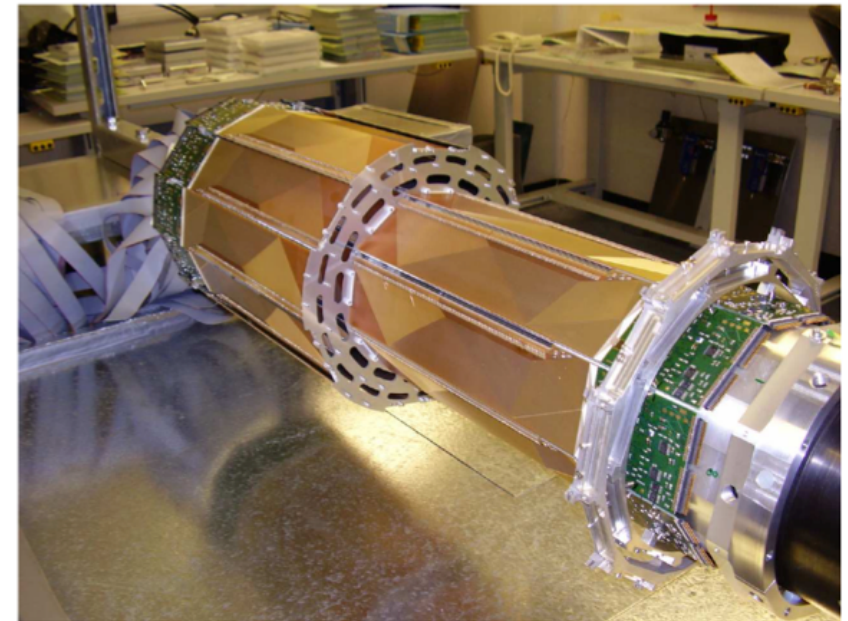
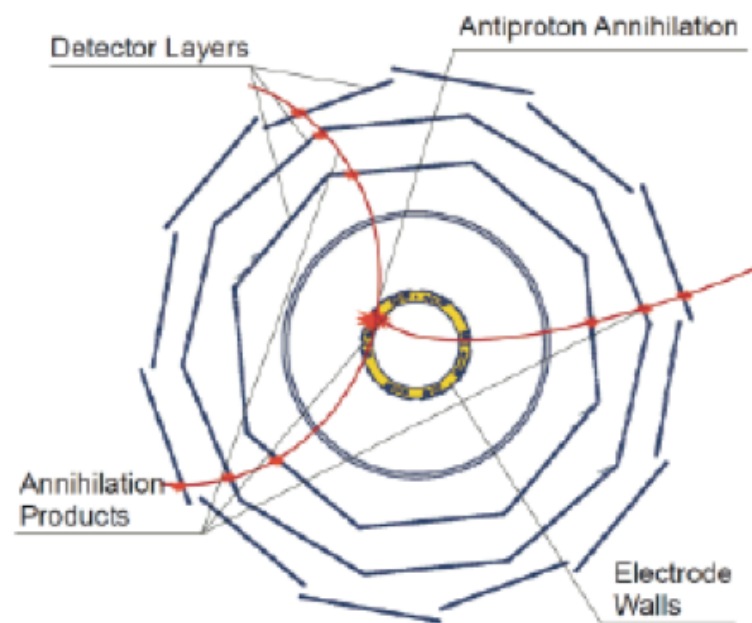
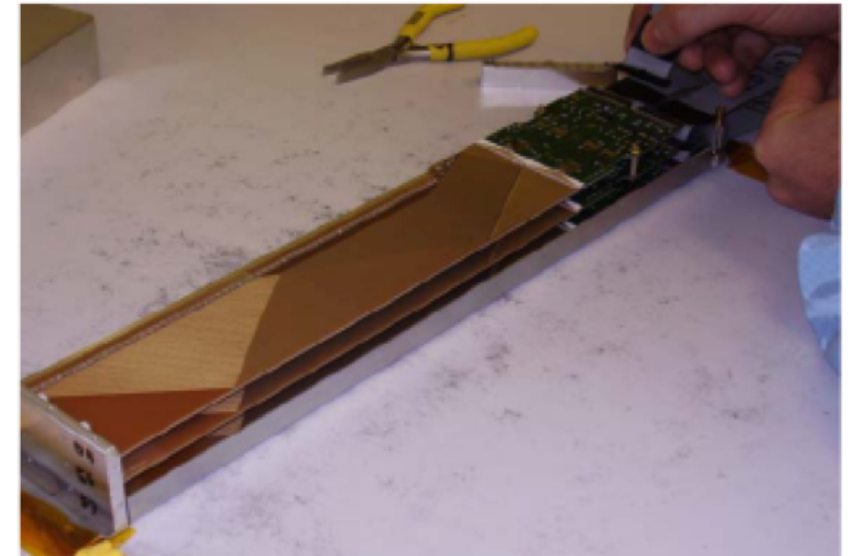



# Trapping Antihydrogen

- Octupole-based *magnetic minimum* trap
  - Octupole + 2 mirrors
- Low-field-seeking magnetic states are trapped
- Shallow potential well: **T < 0.5 K**

$$\vec{F} = \mu_H \vec{\nabla} |\vec{B}|, \quad U = \vec{\mu}_H \cdot \vec{B}$$

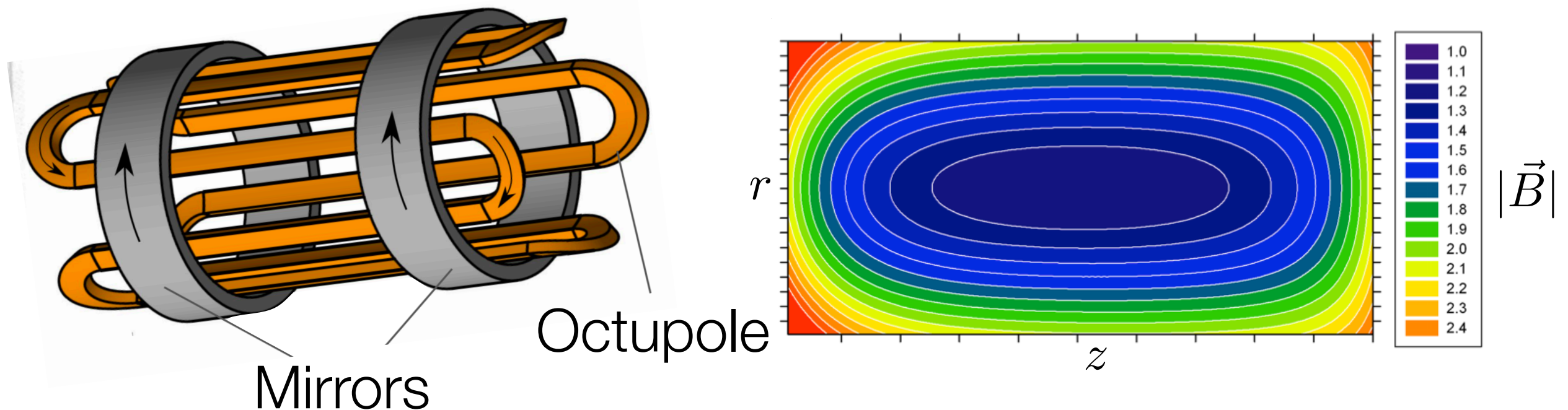

# *A little ALPHA history*

## Trapping Antihydrogen: Search

---

1. Turn on magnetic trap
2. Mix and Form Antihydrogen
3. Eject remaining charged particles
4. Rapidly shut off trap (< 30 ms quench in ALPHA-1)
5. Detect annihilations

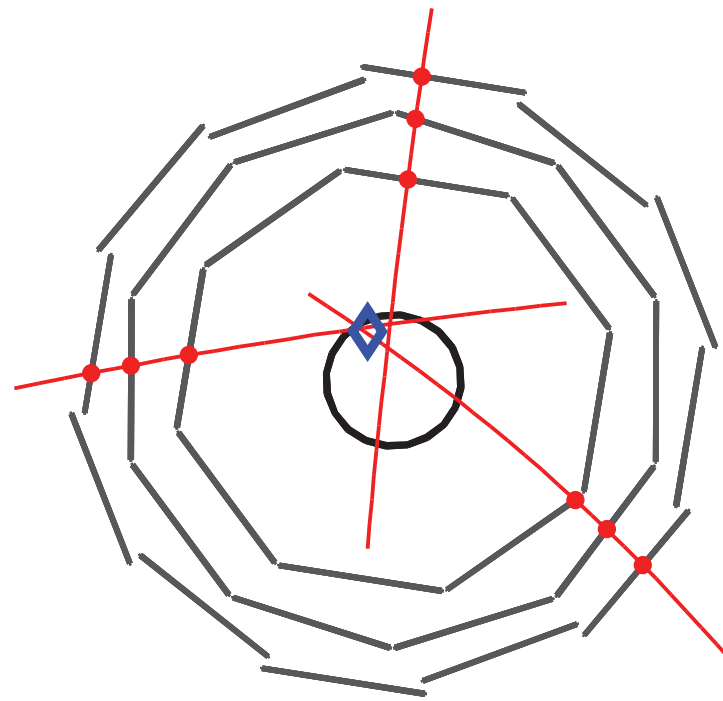

# A little ALPHA history

## Trapped Antihydrogen Detection

- Pattern / Time / Spatial Information from Detector
- Reject cosmic rays
- Accept antiproton annihilations
- Only look at events during the quench (time)

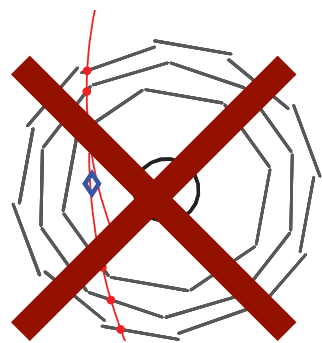

Cosmic Ray

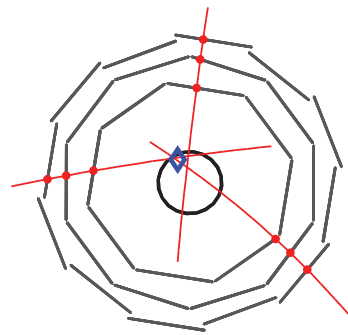

Antiproton

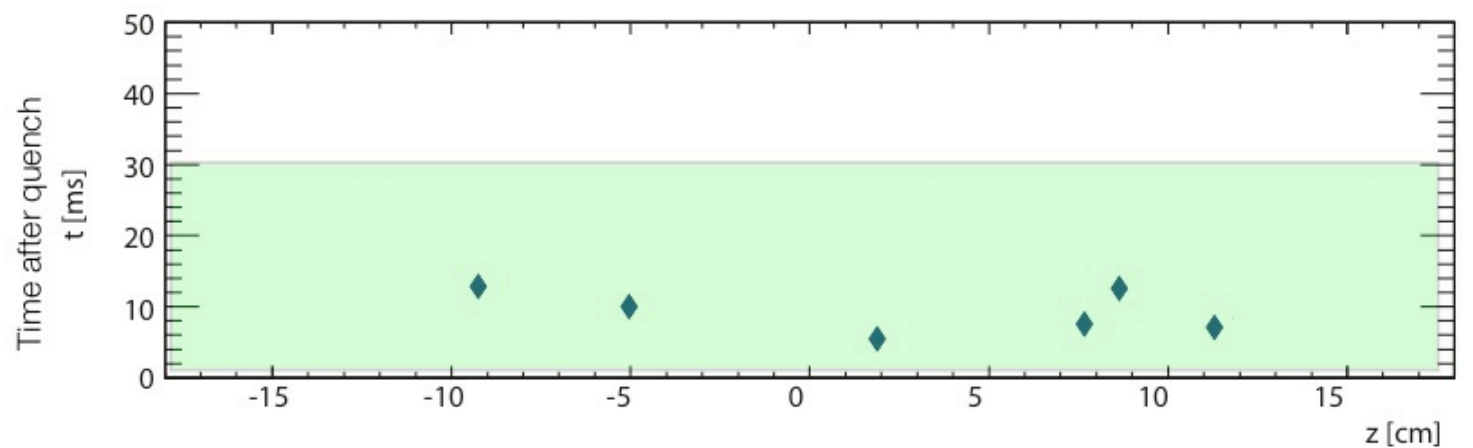

# *A little ALPHA history*

## Antihydrogen Expectation?

---

- Simulate Antihydrogen atoms in trap through quench

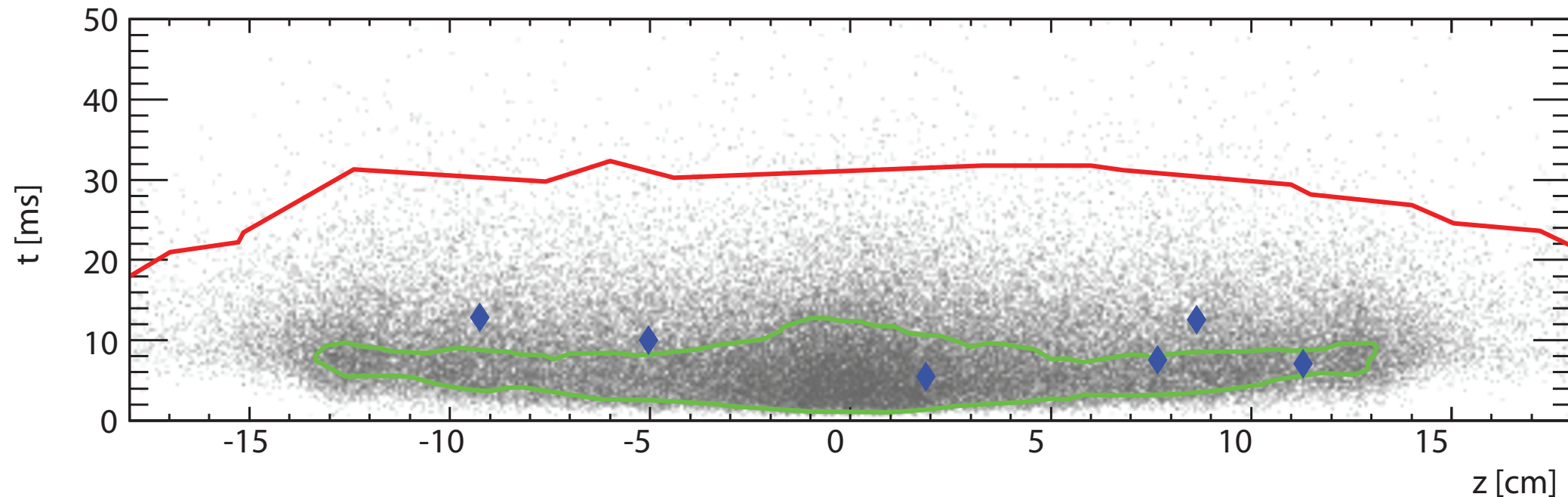

- Mirror-trapped antiprotons might remain...

# A little ALPHA history

## High $E_{\perp}$ , Mirror-Trapped Antiprotons Background?

- *Simulate behavior of atoms and antiprotons in potential*
  - *Antiprotons with high perpendicular energy can be mirror-trapped by B fields*

$$U_{\bar{p}}(z, r = 0) = q(\phi - \phi_0) + E_{\perp} \frac{B_{\parallel} - B_0}{B_0}$$

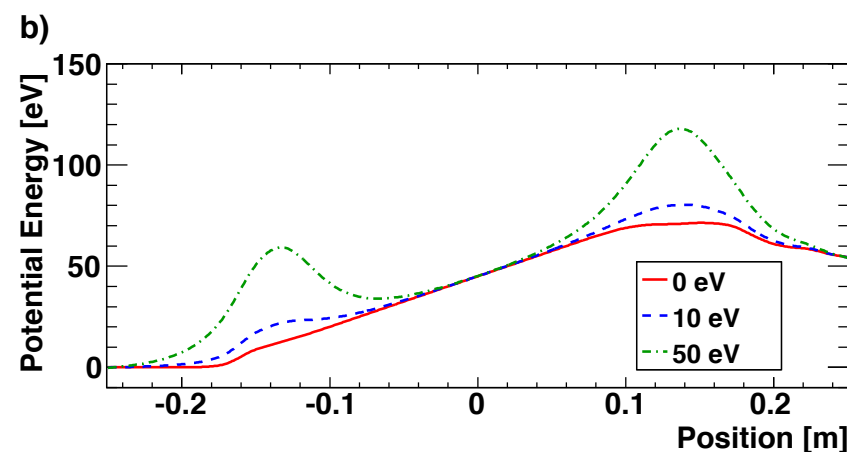
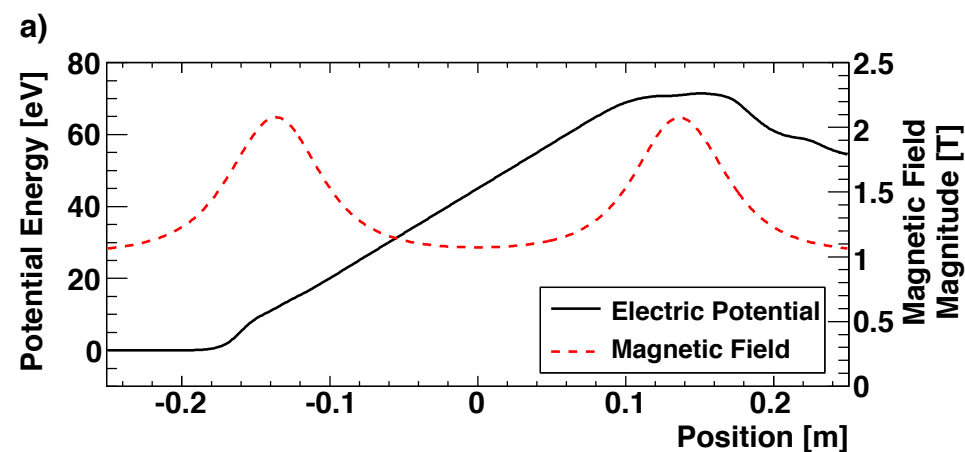

# *A little ALPHA history*

## Are events Mirror-Trapped Antiprotons?

- Simulate mirror-trapped antiprotons in quench

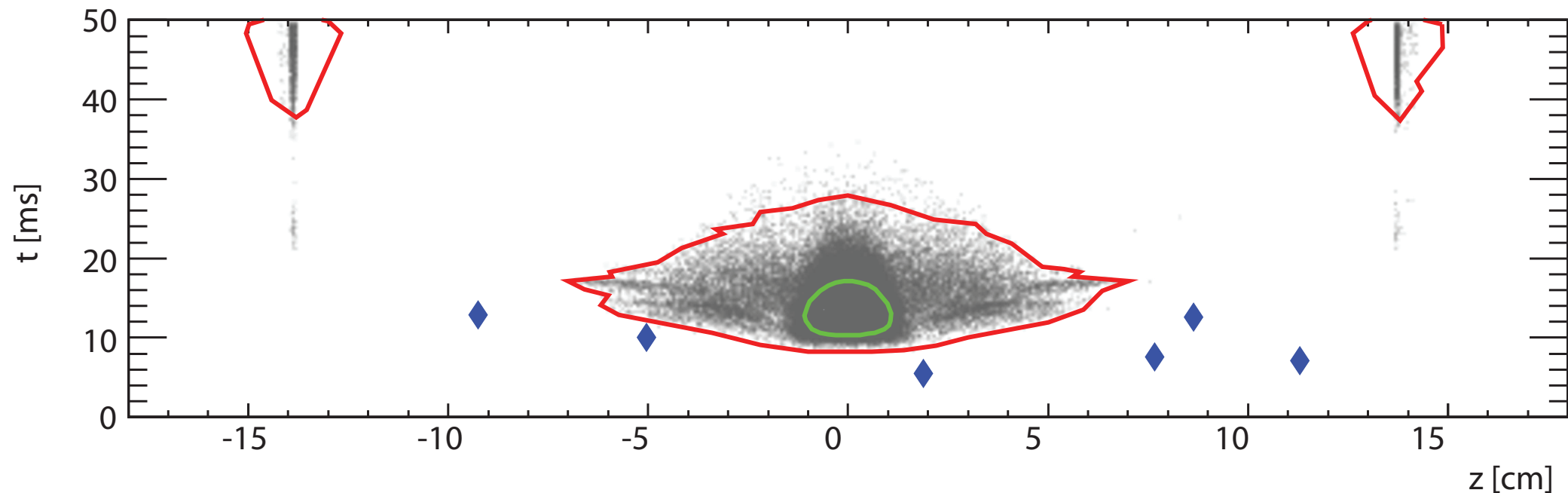

- Different from antihydrogen events, surely...



# A little ALPHA history

## Quench With Bias Electric Field

- Electric *Fields deflect charged particles, not atoms*
- Simulate and measure with high  $E_{\perp}$  antiprotons

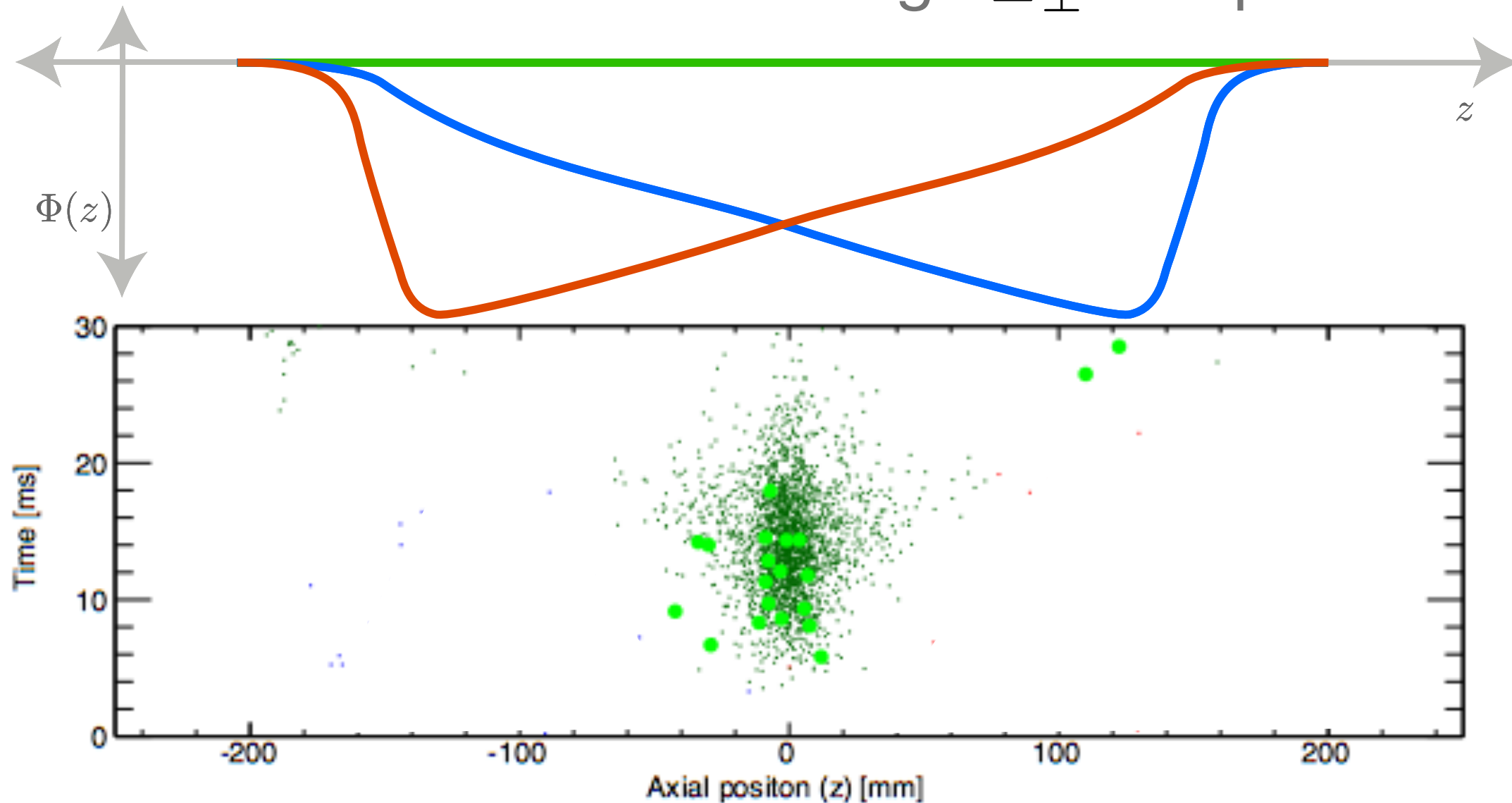

# A little ALPHA history

## Antihydrogen Search with Bias Fields

- No spatial bias in signal: Trapped Antihydrogen

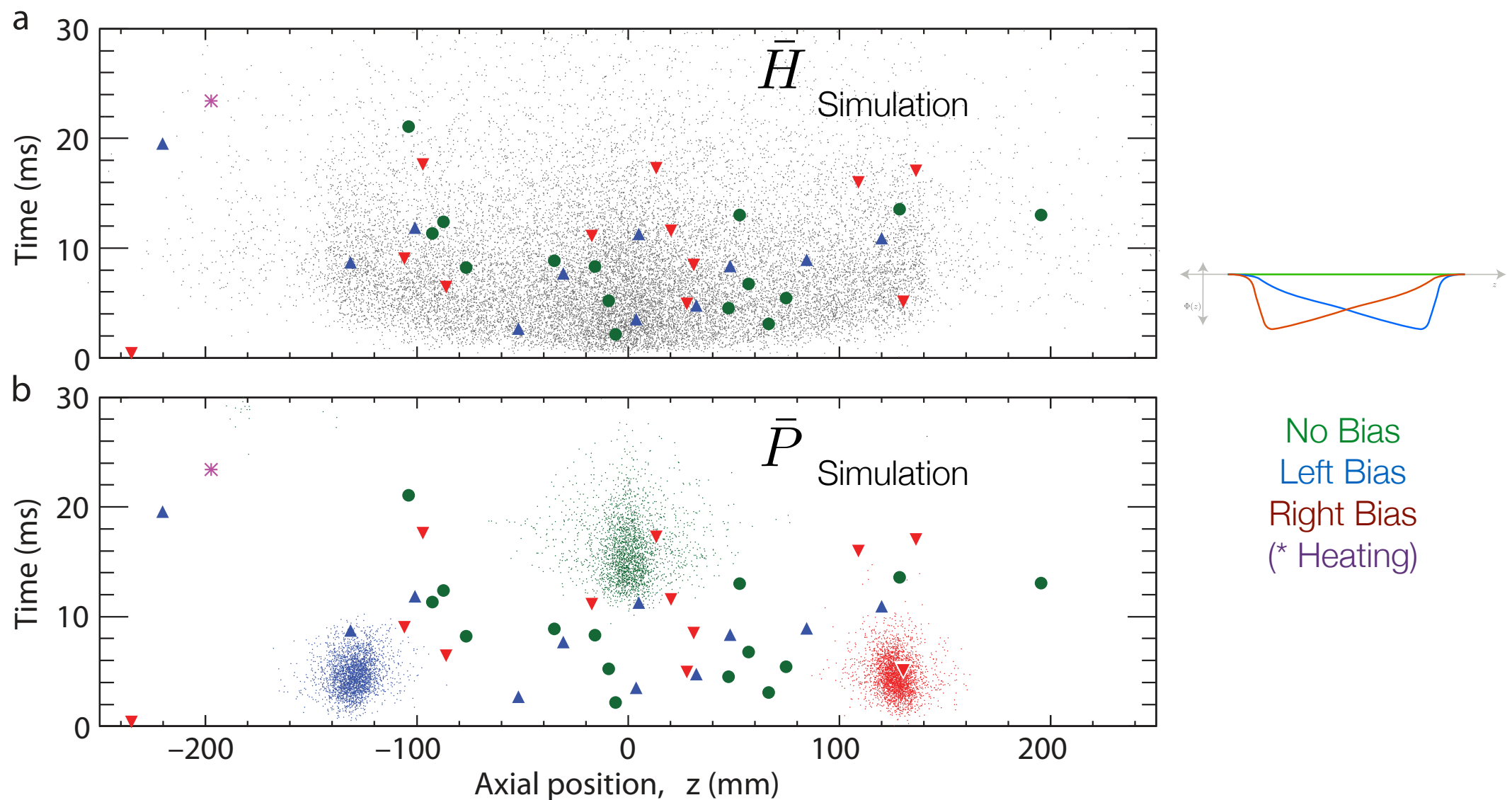

E. B. Andresen *et al.* "Trapped Antihydrogen", *Nature* 468, 673–676

# Measurements with Potentials: Charge neutrality

---

- What if the **E**-fields did deflect the atoms?
- Antihydrogen “charge anomaly”

$$\bar{H} \text{ charge} = Qe$$

- Magnetic atom trap + bias field potential:

$$U(z) = \mu_{\bar{H}} B(z) - \frac{QeE}{k_B} z$$

# Measurements with Potentials: Charge neutrality

Simulate Hbar Annihilations

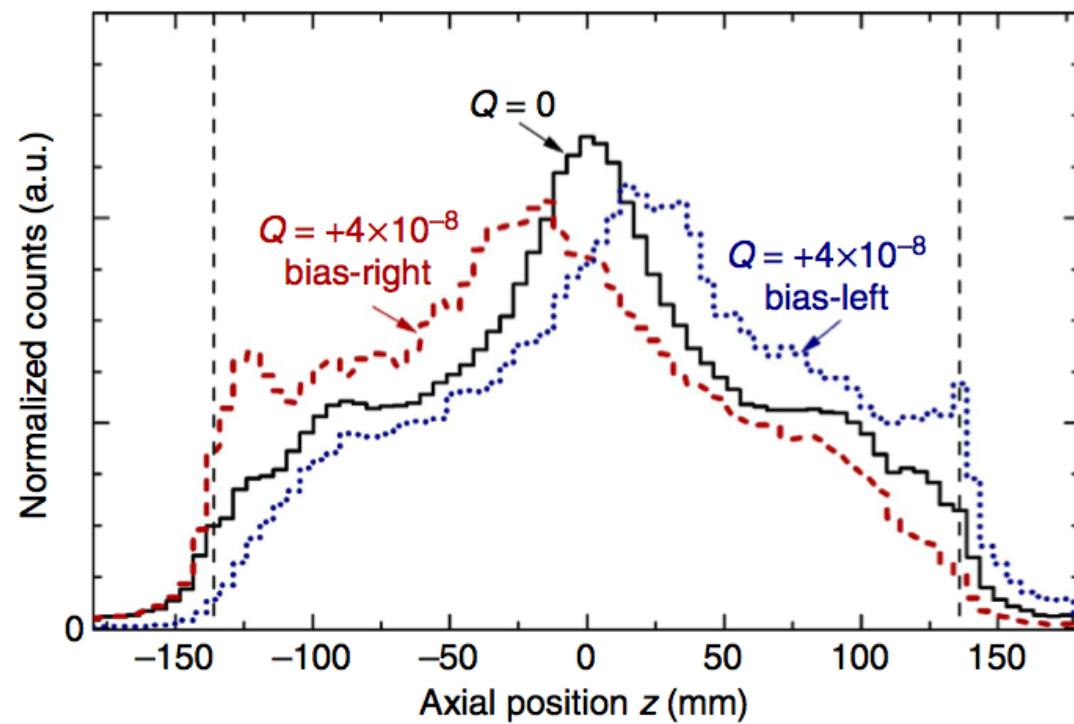

Relate  $\langle z \rangle_{\Delta} \leftrightarrow Q$

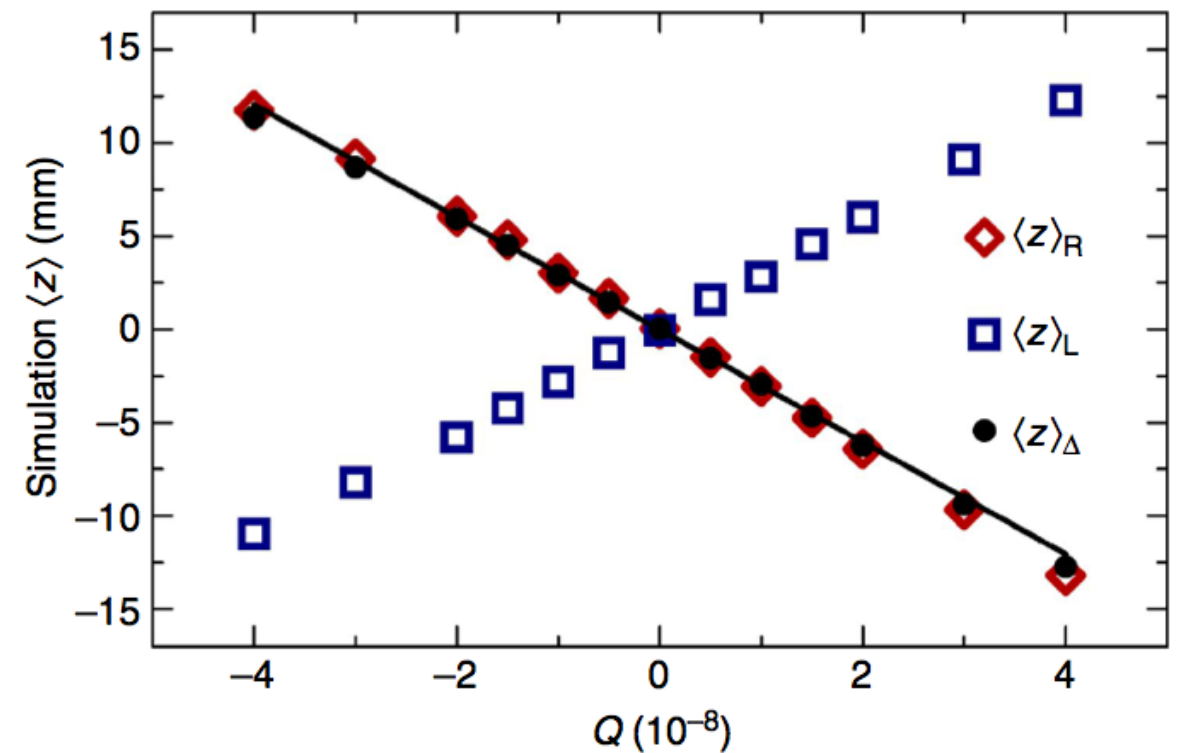

$$Q = \frac{4\mu_{\bar{H}}\beta k_B}{e(E_R - E_L)} \langle z \rangle_{\Delta}$$

# Measurements with Potentials: Charge neutrality

Measure  $\langle z \rangle_{\Delta}$

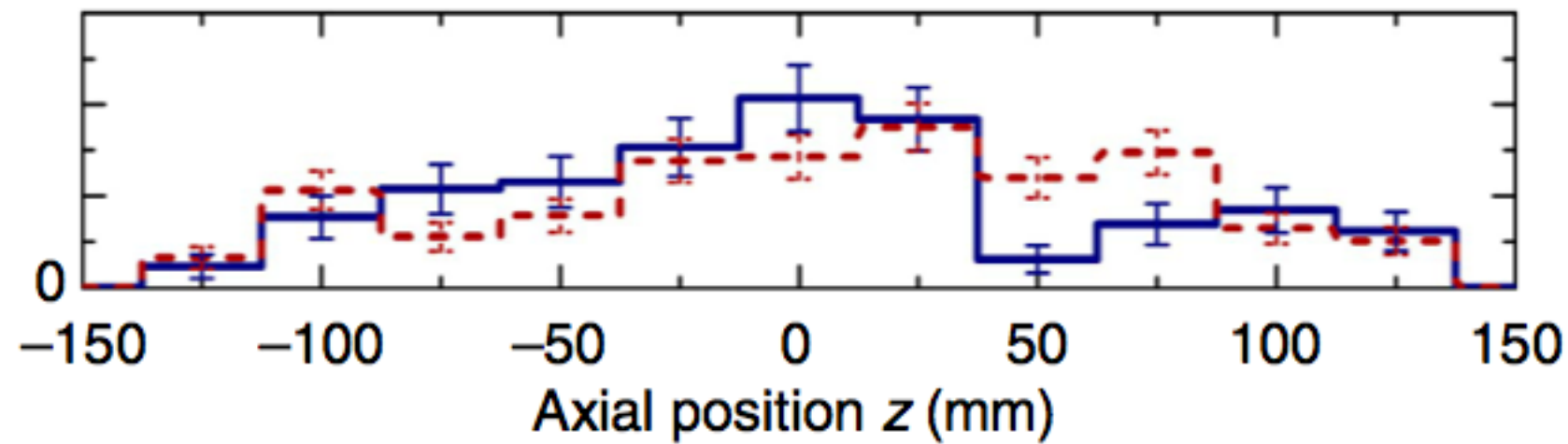

$$\langle z \rangle_{\Delta} = 4.1 \pm 3.4 \text{ mm}$$

$$Q = (-1.3 \pm 1.1 \pm 0.4) \times 10^{-8}$$

C. Amole *et al.* “An experimental limit on the charge of antihydrogen”, Nat. Comm. 5, 3955 (2014)

# Measurements with Potentials: Gravitation?

- Do atoms and anti-atoms gravitate differently?

$$F_{\text{antimatter}} = F \cdot mg$$

$$U(y) = \mu_{\bar{H}} B(y) + F \cdot mgy$$

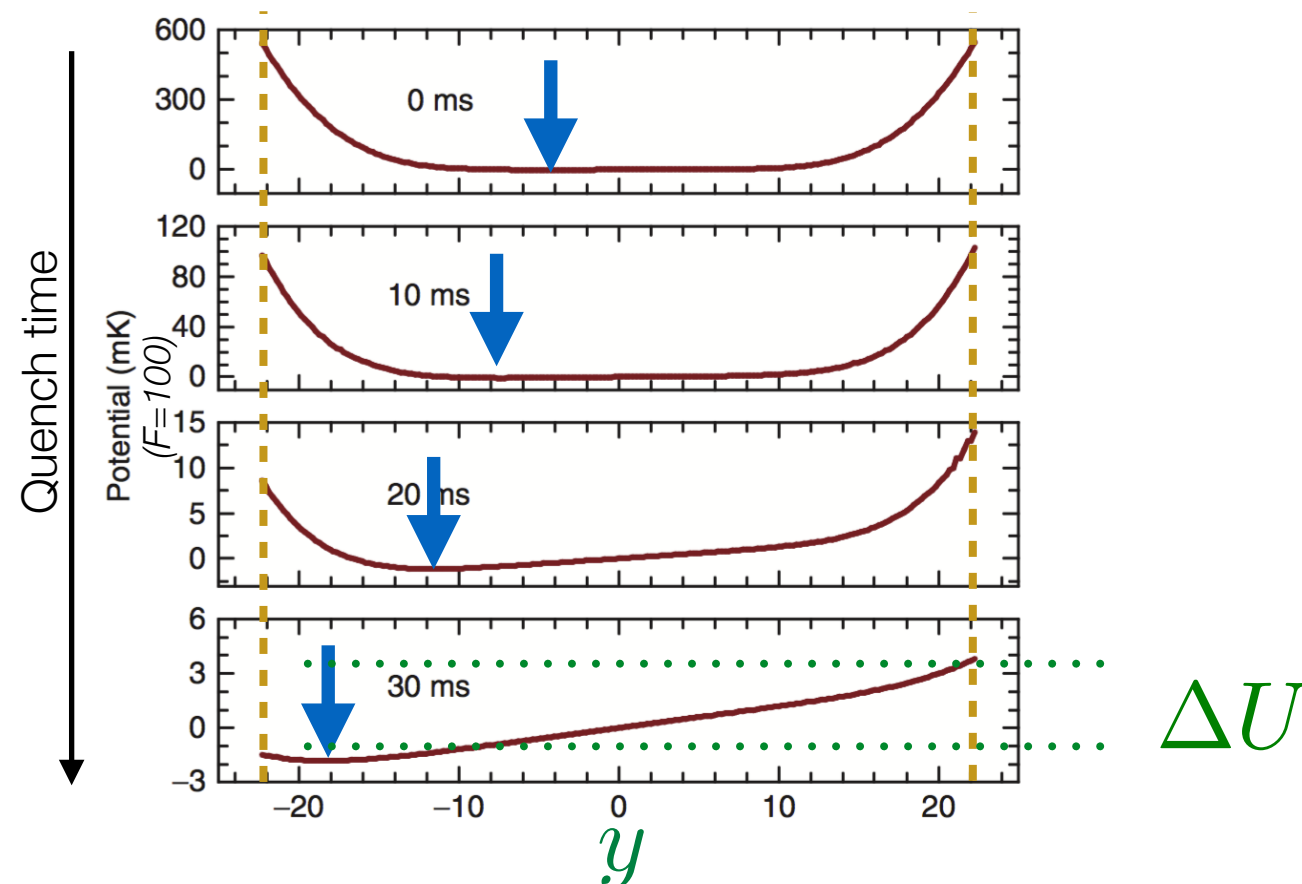



# Measurements with Potentials: Gravitation? (ALPHA-1)

- Antihydrogen will fall out the bottom (or top) of the trap

$$F_{\text{antimatter}} = F \cdot mg$$

• Simulation for  $F = 100$

⊙ Data

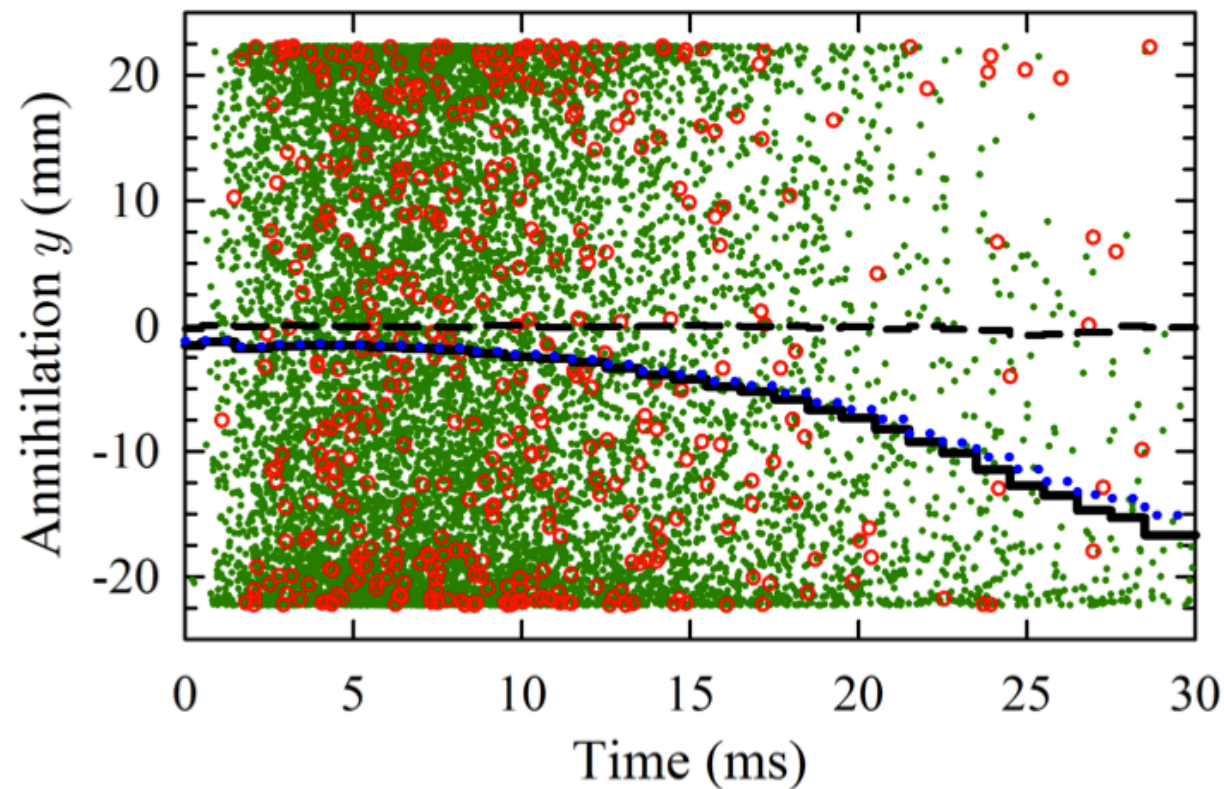



# Measurements with Potentials: Gravitational Deflection: Precision?

- Simulate various  $F$ , *exclude*  
 $-65 < F < 110$
- Not very precise!
  - short distance, hot population!
- ***Need over 200 meters for deflecting hydrogen!***

$$\Delta U_{F=1} \approx 10^{-3} \text{ mK mm}^{-1}$$

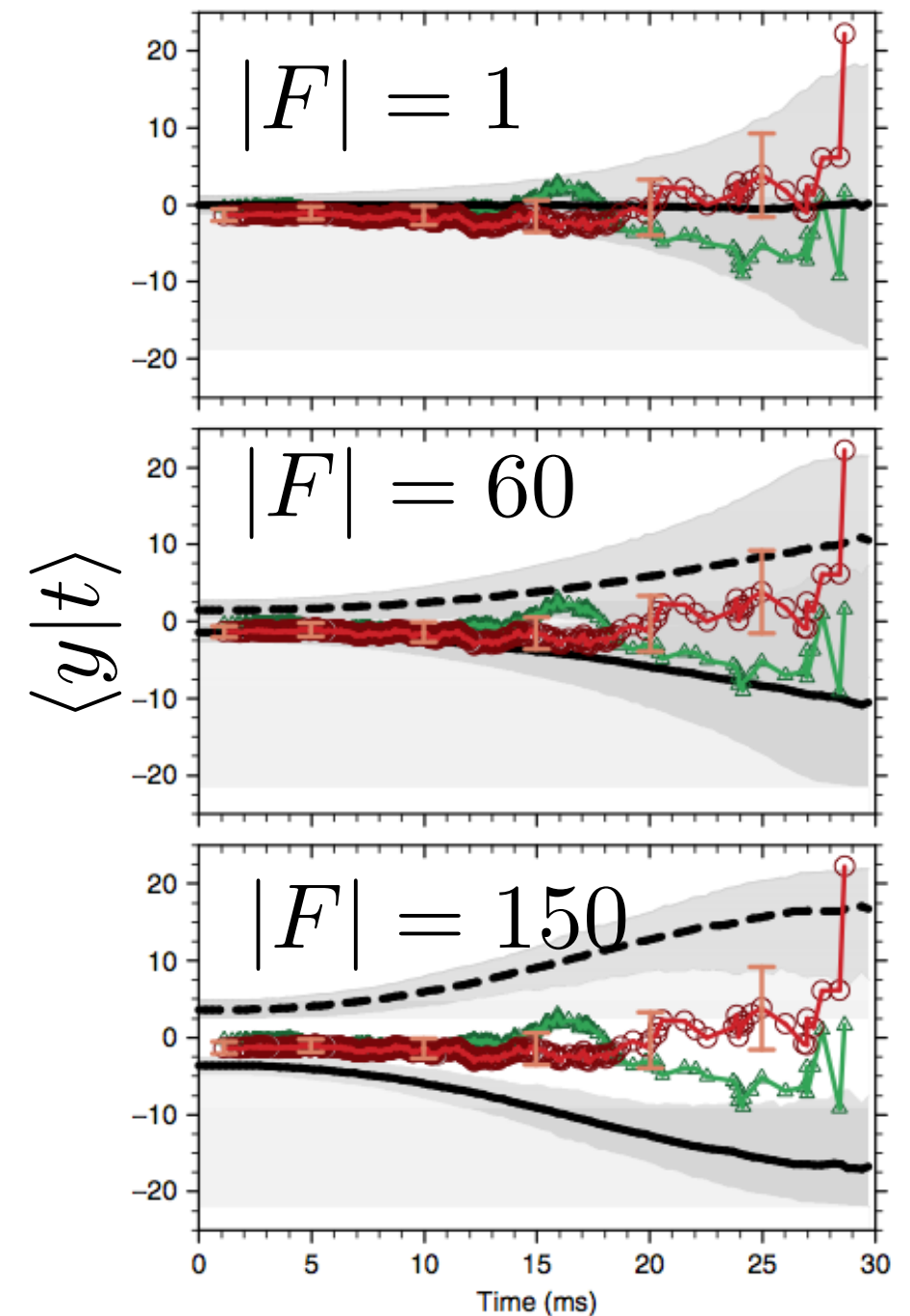

NATURE COMMUNICATIONS | 4:1785 | DOI: 10.1038/ncomms2787 | [www.nature.com/naturec](http://www.nature.com/naturec)



# ALPHA-g: an antimatter gravity experiment

---

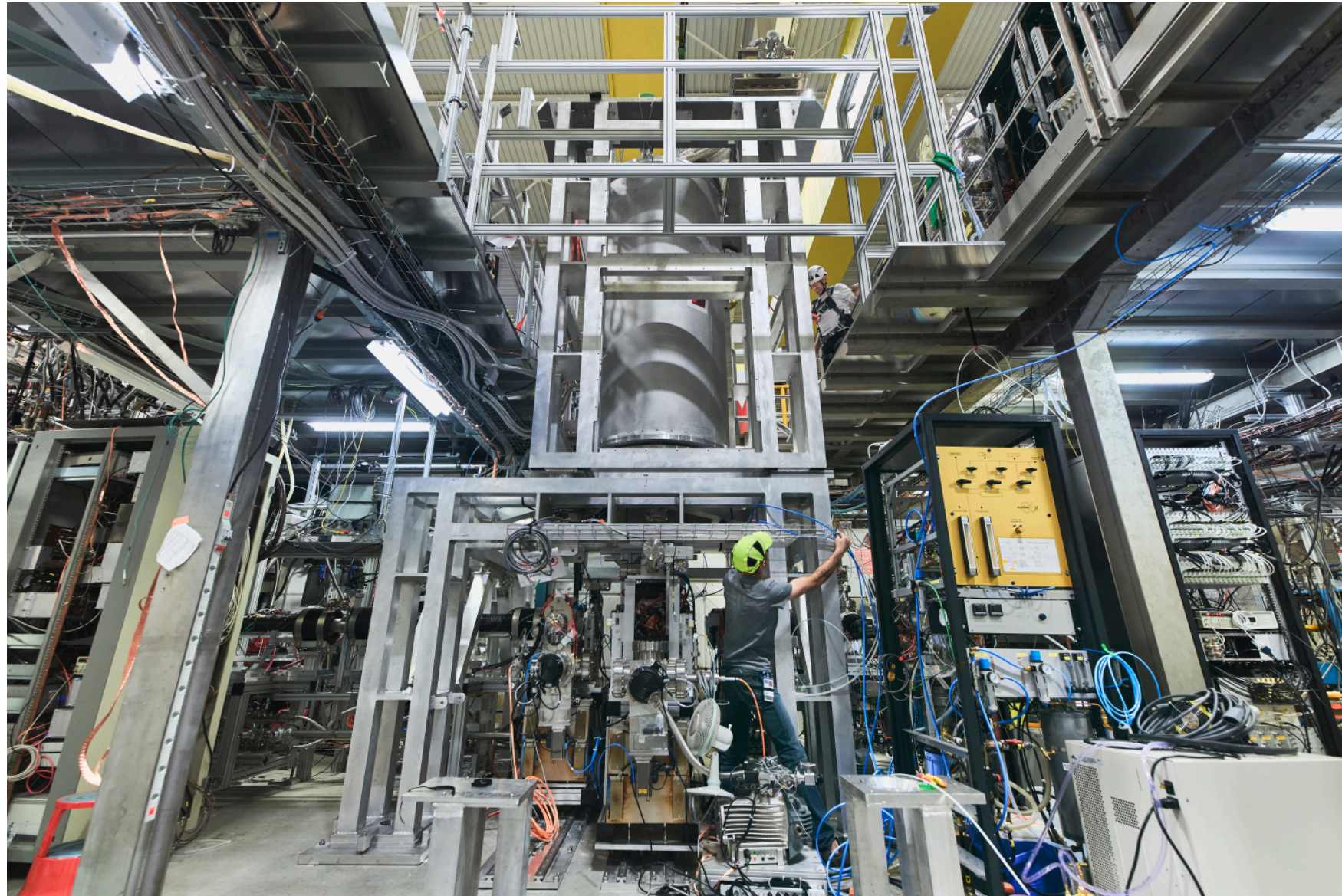





P. Traczyk and M. Brice, CERN <https://cernbox.cern.ch/s/3OAsgoCXxXMPTas>



# A simple Up / Down measurement: Matched fields

Magnetic + Gravitational potential

DOWN

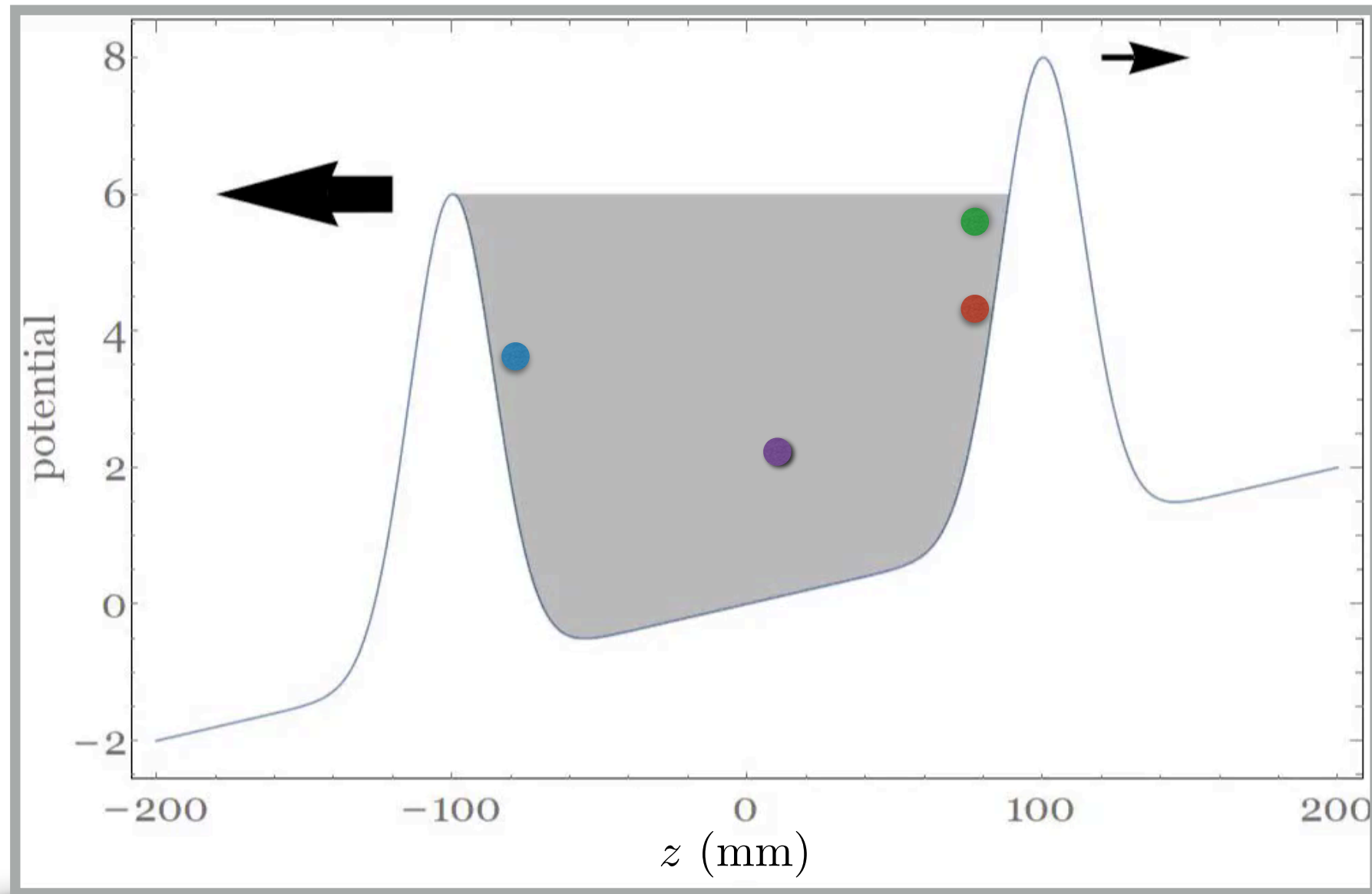

UP

$$U(z) = \mu_H B(z) - mgz$$

W. Bertsche, "Prospects for comparison of matter and antimatter gravitation with ALPHA-g", RSTA, 376, 2116, 2018

# A simple Up / Down measurement: Matched fields

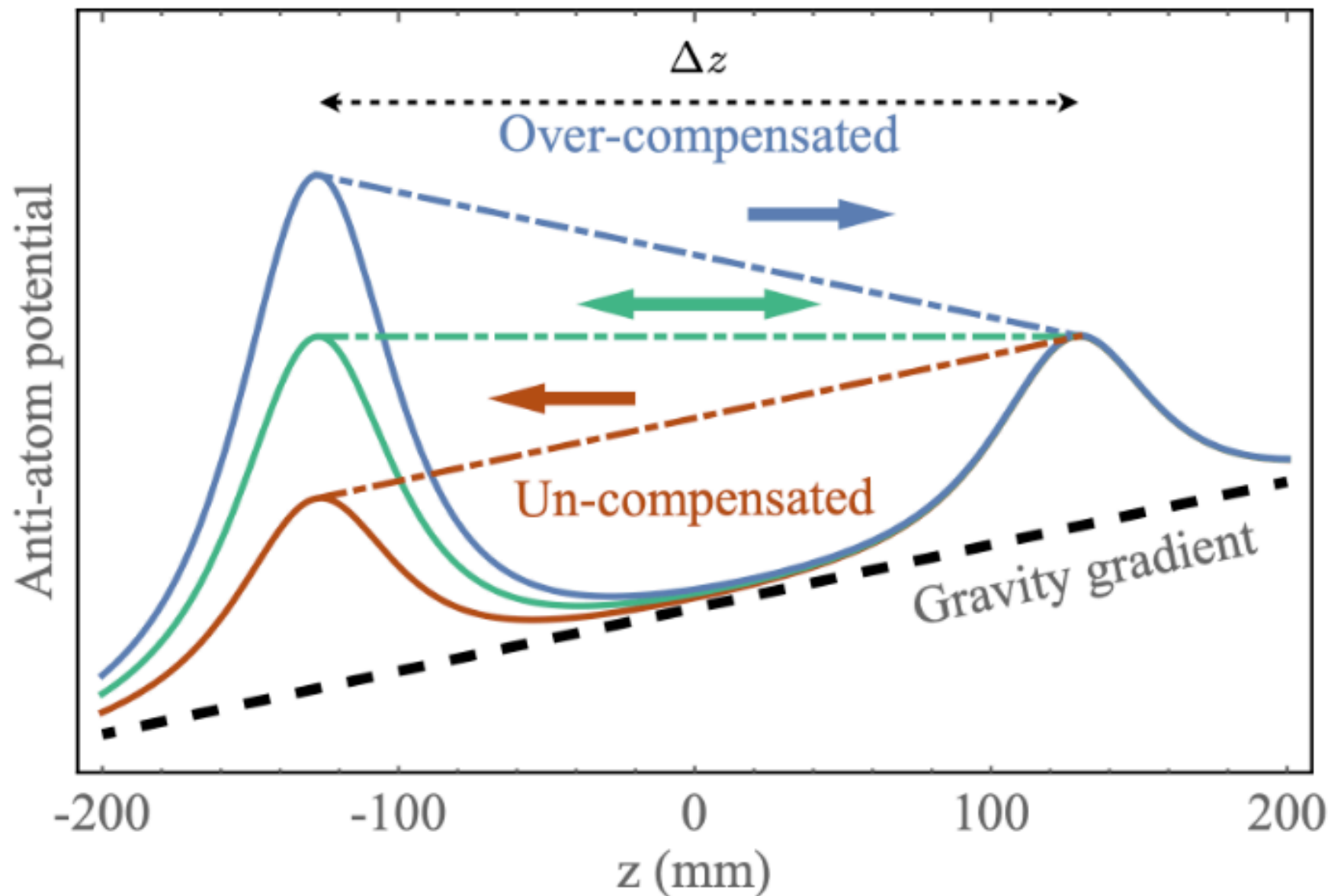

Matched,  
Uncompensated  
B-Field

500 mK atoms:  
~20% up,  
~80% down

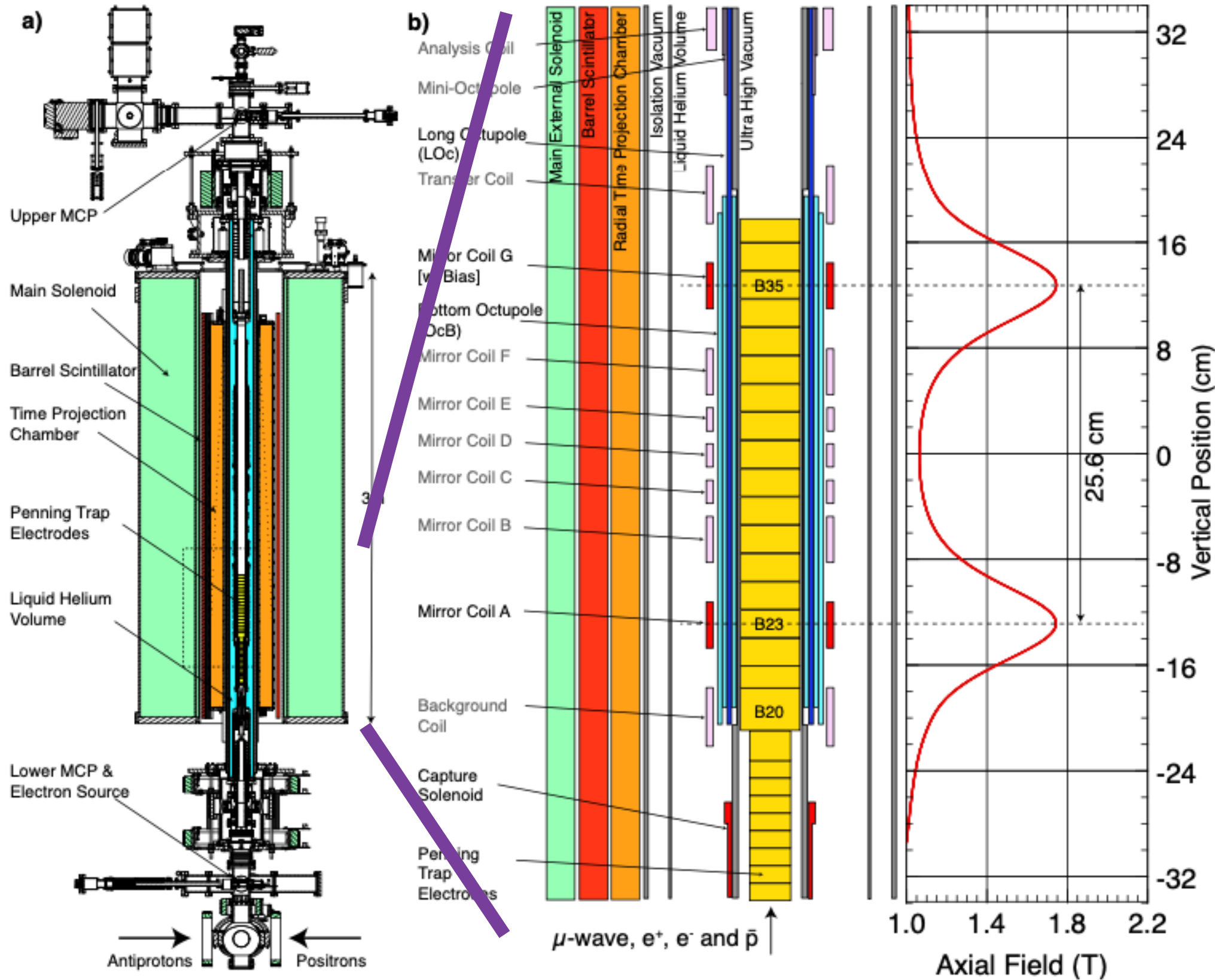

# ALPHA-g Antihydrogen Detection

- Radial Time Projection Chamber (rTPC)
- Barrel Scintillator Veto (cosmics)
- z-resolution  $\sim 2$  cm ( $\ll 25.6$  cm)

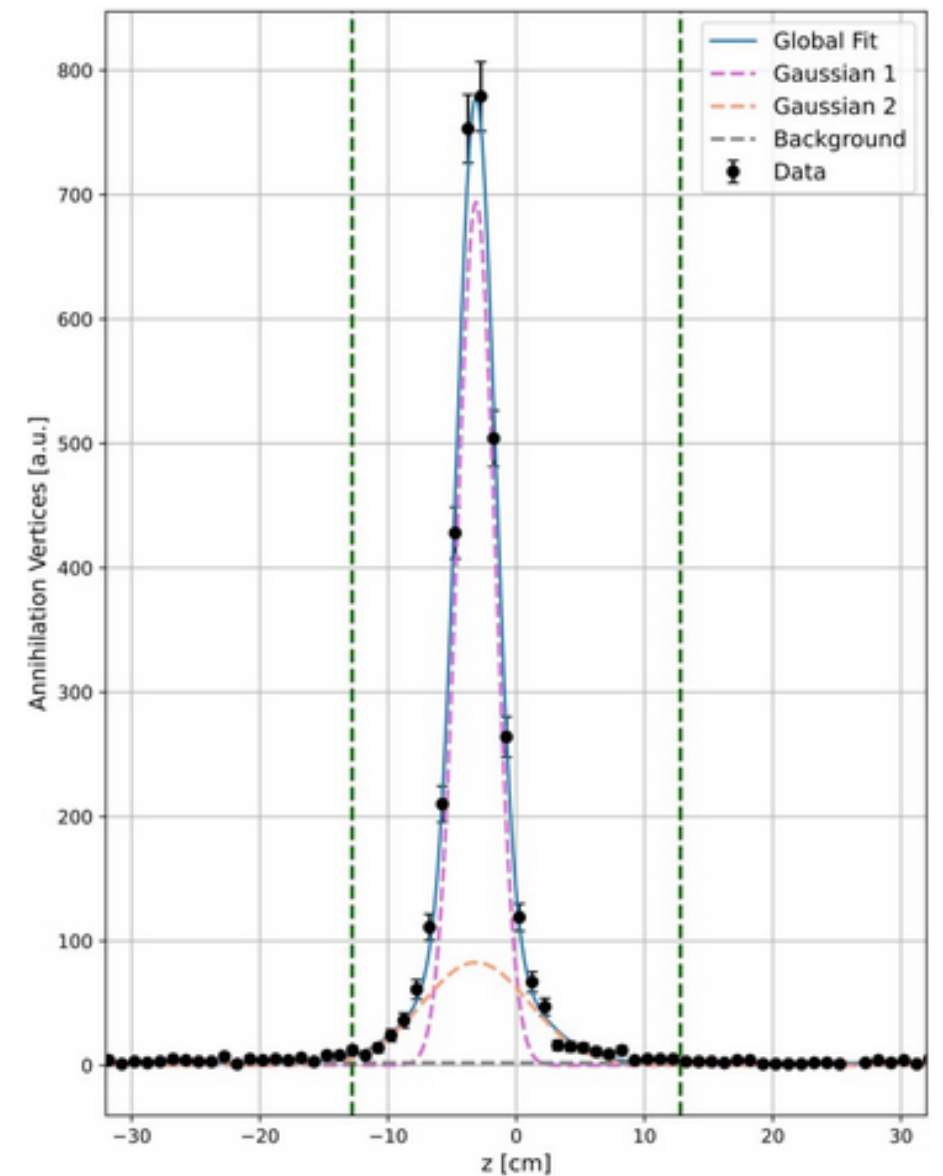
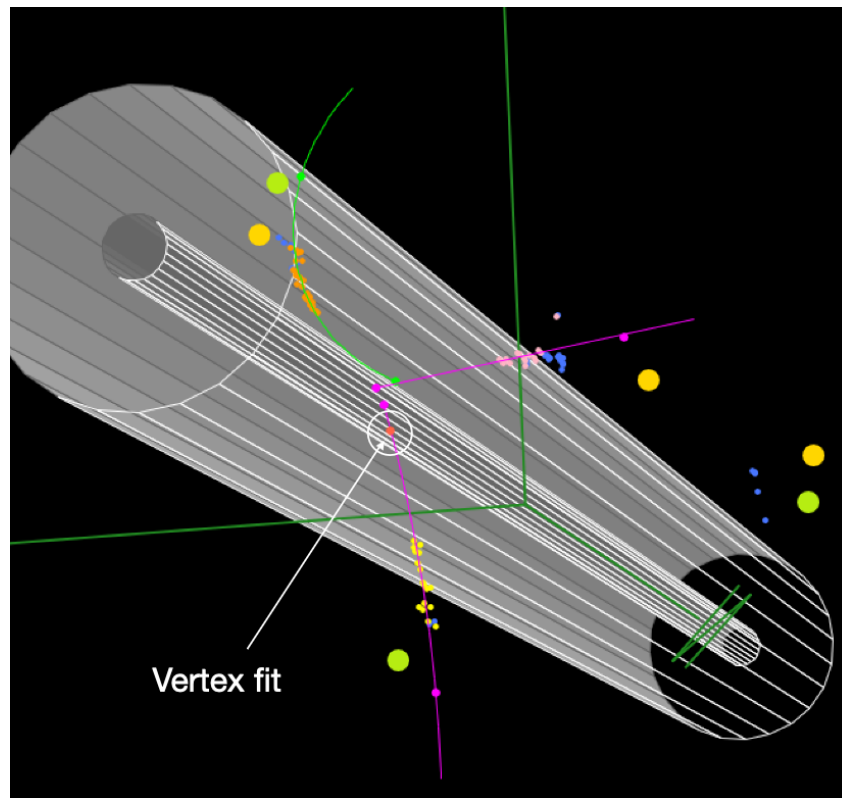



# ALPHA-g magnets

- Duplicated Bottom and Top traps
  - Strong octupoles for initial trapping
- Precision Analysis Region
- Long octupole running the full length of machine
  - Transfer Hbar between regions

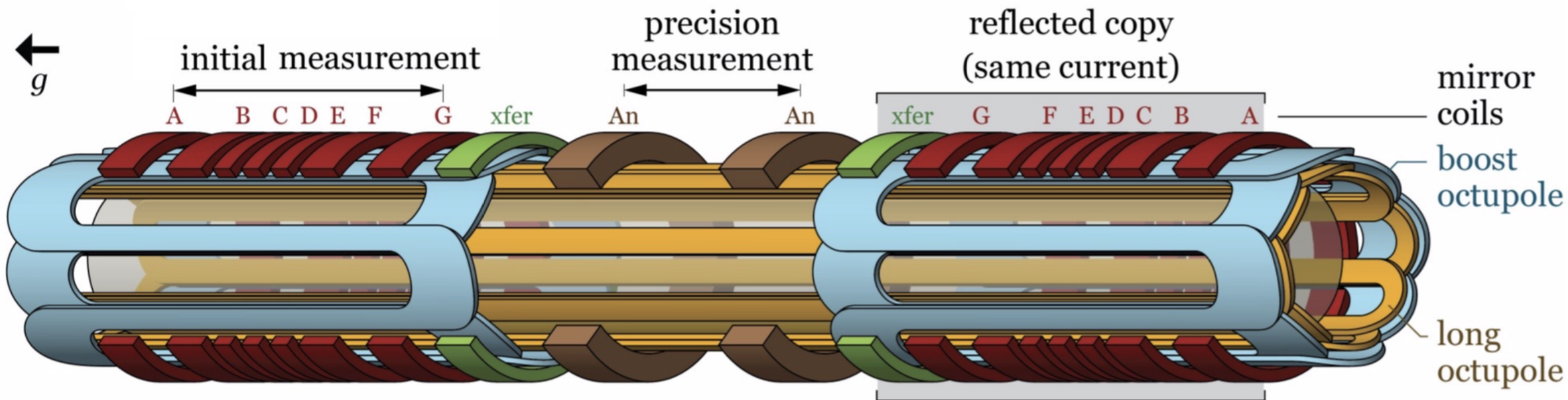

# Magnetic Balance

- 1 g balance 'bias' ~ **-4.5 Gauss** across Mirrors A-G
- Magnetic bias in units of  $9.81 \text{ m/s}^2$

$$\text{bias} = \frac{\mu_B (B_G - B_A)}{m_H (z_G - z_A)}$$

$$\Delta B_{1g} \sim 4.5 \text{ Gauss}$$

$$\Delta U_g \sim 300 \mu\text{K}$$

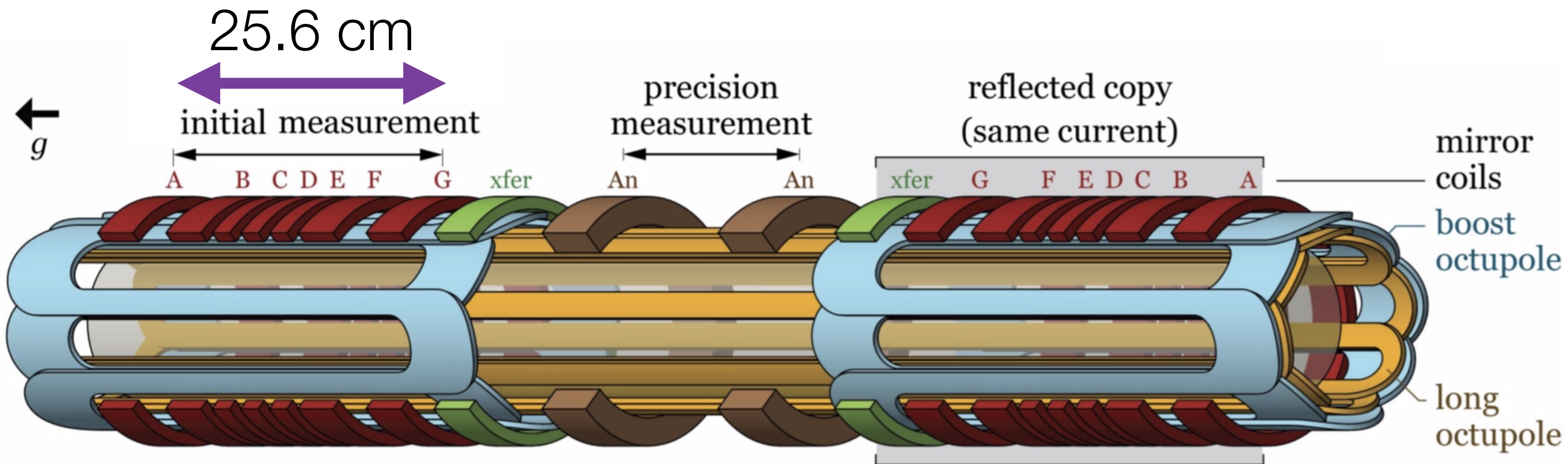

# Magnetic Balance

- 1 g balance bias  $\sim -4.5$  Gauss
- Nominal bias from field map

$$\text{bias} = \frac{\mu_B (B_G - B_A)}{m_H (z_G - z_A)}$$

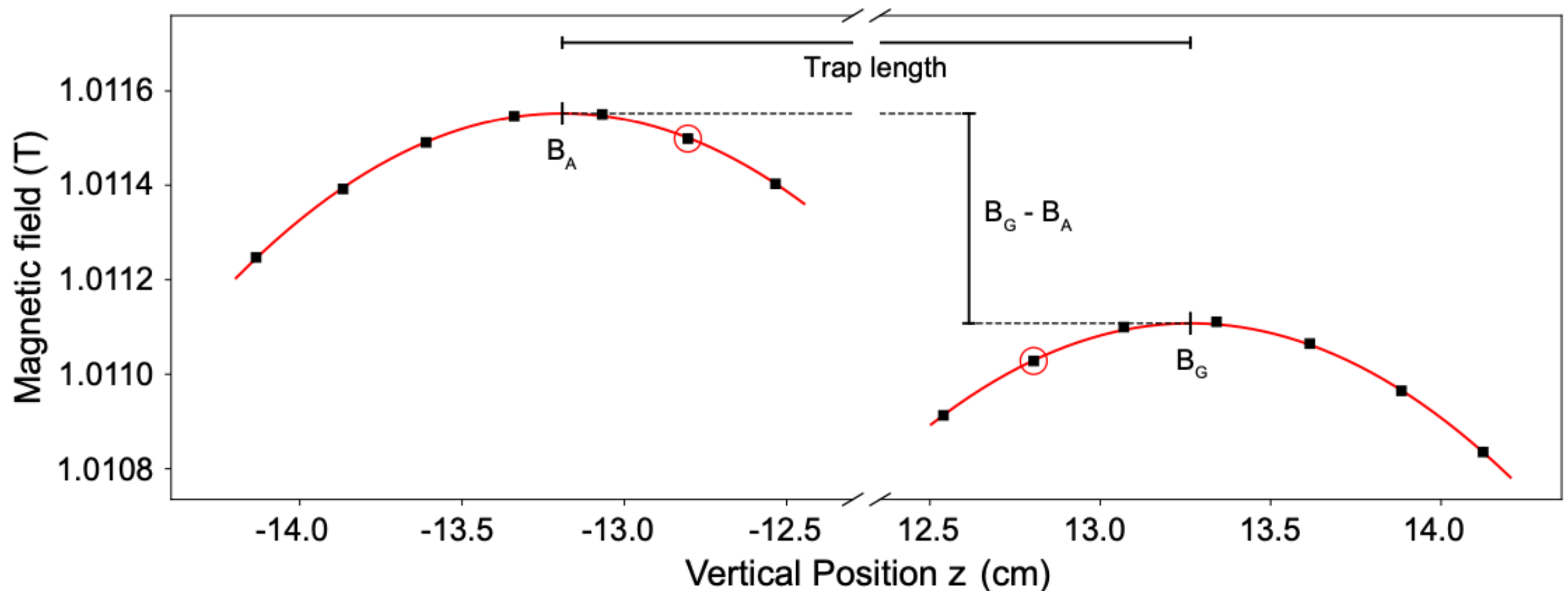



# Magnet Construction

- Goal is to make Bottom and Top identical at 0.01%
- Monitor construction on each layer - feedback to next
- Measure field differences, correct with current

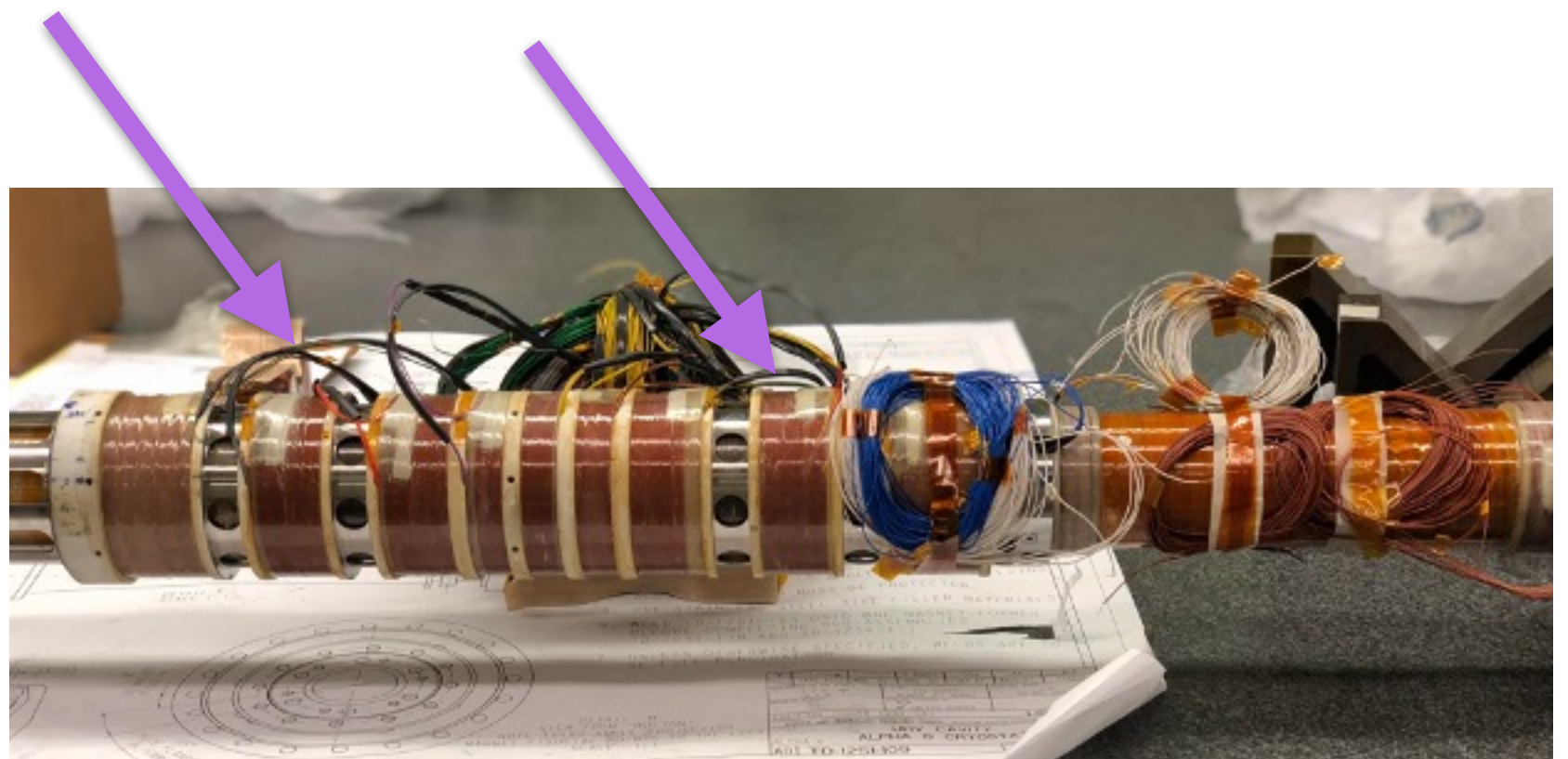
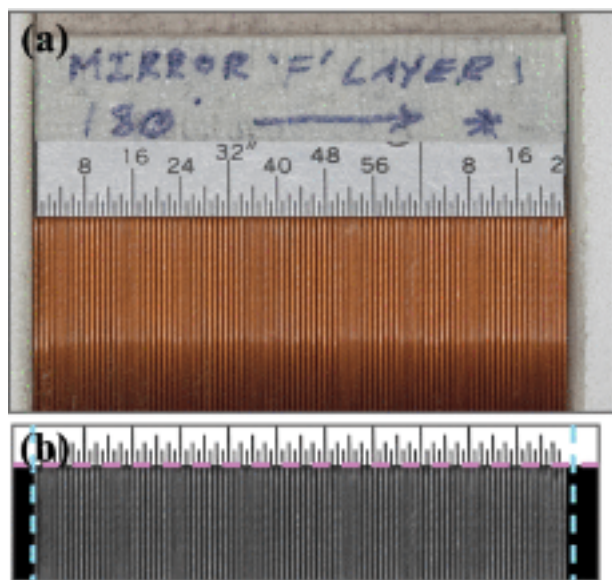

# Magnet Current Control

- Need continuous sub-mA control of currents
- Full mirror fields  $\sim 70$  A in series
- **Importance is *difference* current**
- Bias + correction maintained by parallel “Tickle” supply

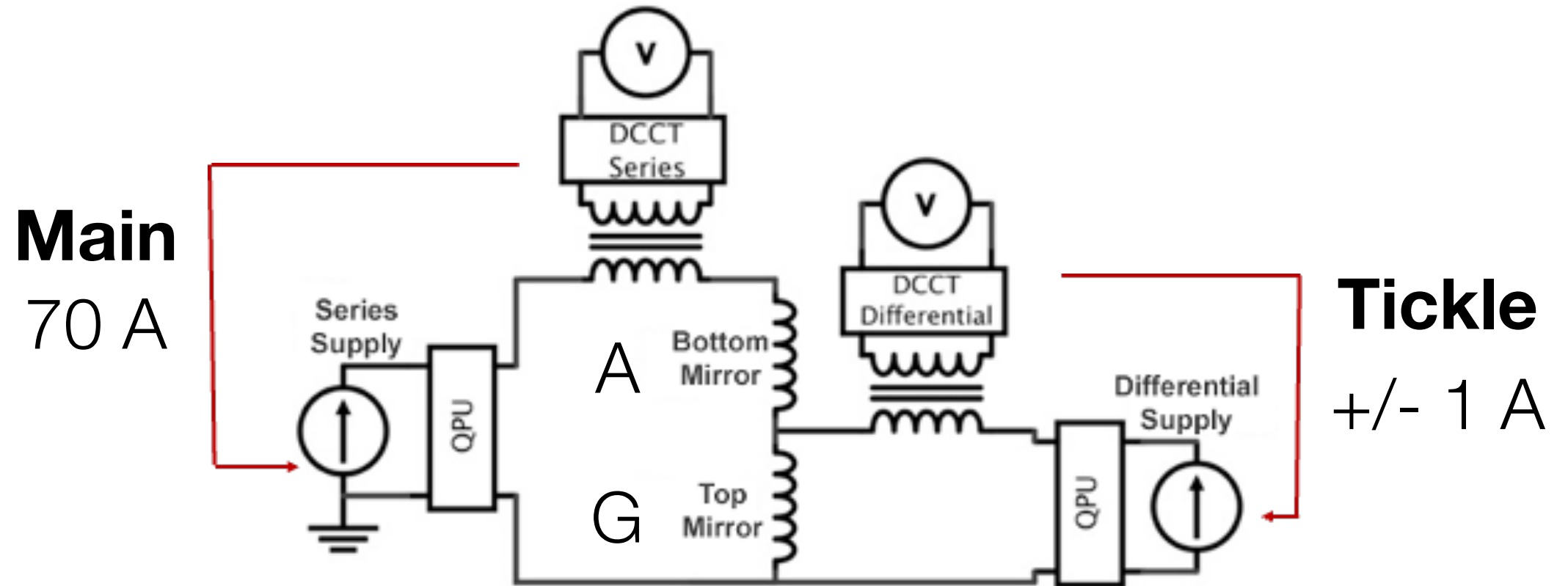

# Magnetic Balance

- 1 g balance bias  $\sim -4.5$  gauss
- $$\text{bias} = \frac{\mu_B (B_G - B_A)}{m_H (z_G - z_A)}$$

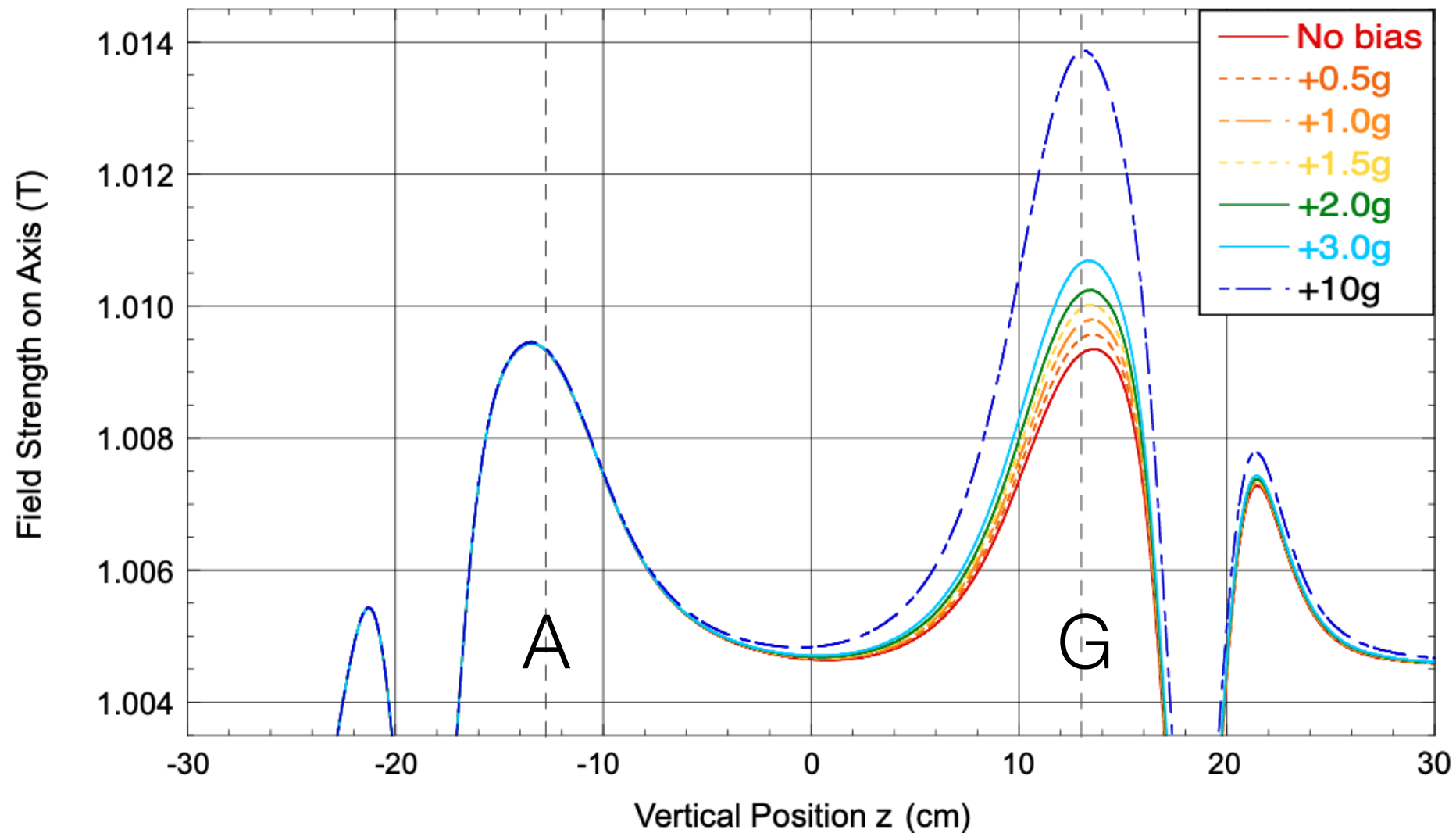



# Magnetic Field Measurements: Probes

---

- Aluminum NMR probe + Hall Probe + temperature
- Insufficient to infer *in situ* fields around the atoms





# Magnetic Field Measurements: ECR

- Localize a plasma in the penning trap
- Illuminate with microwaves:
- Electron Cyclotron Resonance: Heats plasma: Spectra
- Accuracy: down to  $\sim 1$  ppm

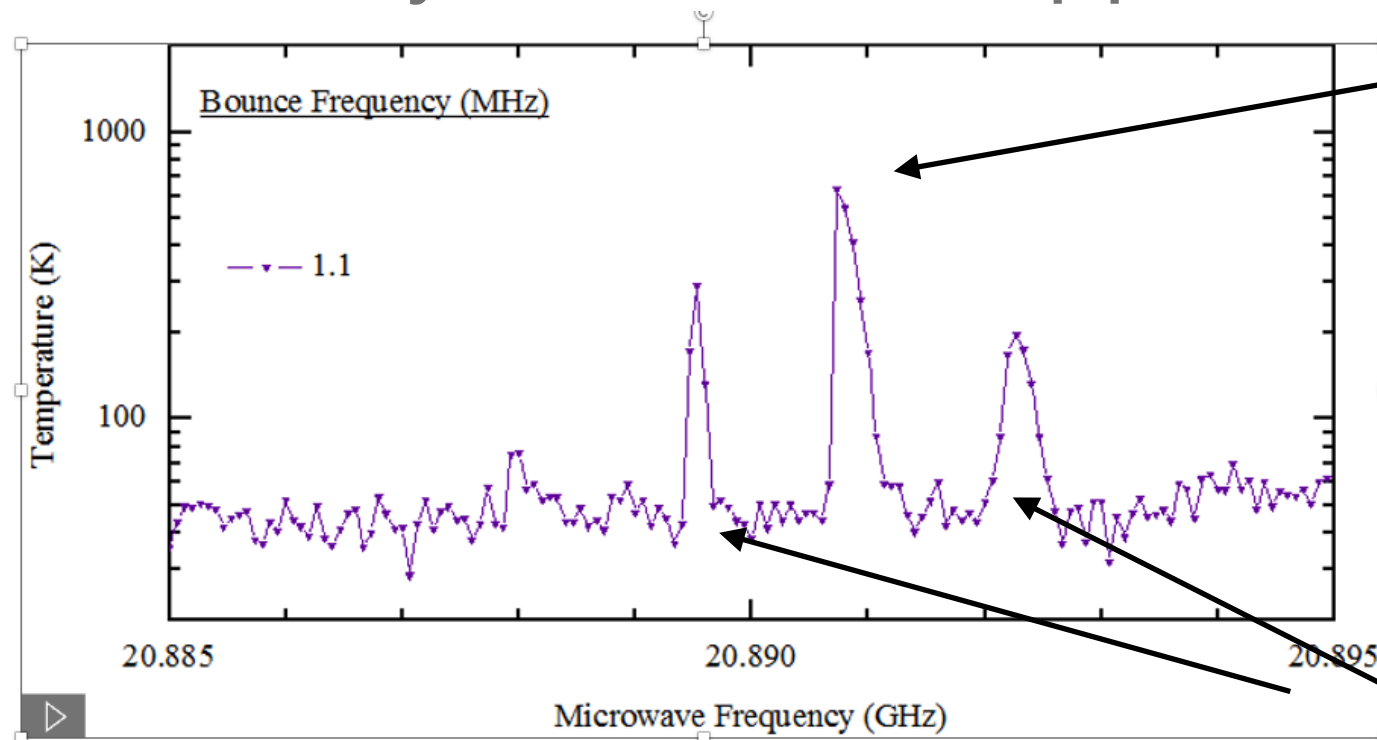

Main ECR resonance

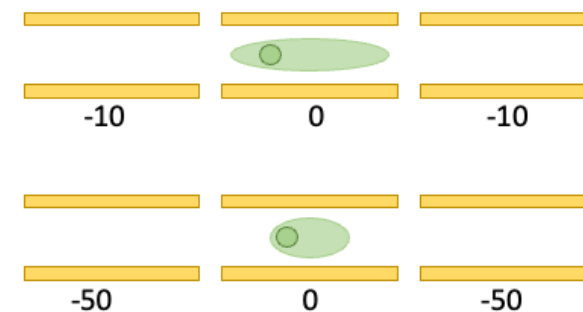

Bounce Resonances

ALPHA, [In situ electromagnetic field diagnostics with an electron plasma in a Penning–Malmberg trap](#), *New J. of Physics*, 16, (2014).

E.D. Hunter, A. Christensen, J. Fajans, T. Friesen, E. Kur, and J.S. Wurtele, [Electron cyclotron resonance \(ECR\) magnetometry with a plasma reservoir](#), *Phys. Plasmas* 27, 032106 (2020).

# Magnetic Field Measurements: ECR

- Localize plasma ‘scoops’ for ECR:  $\sim 1$  mm resolution
- Map field in time / location
  - Relatively slow (many scoops)

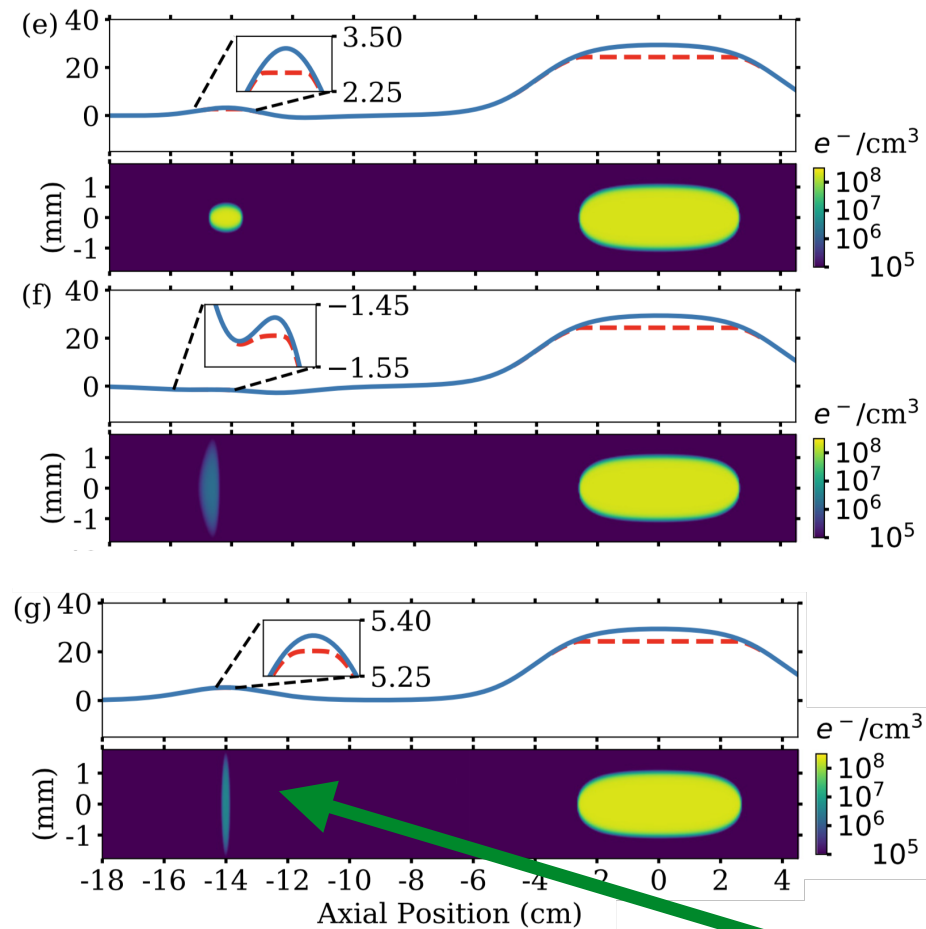
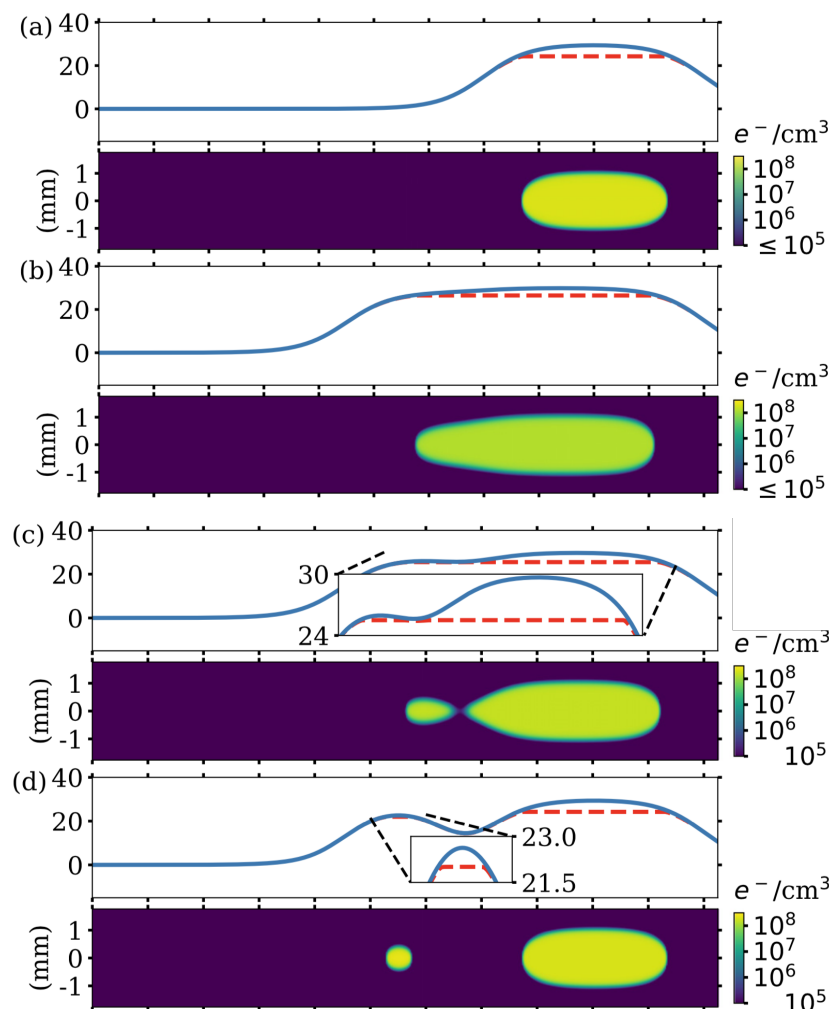

Microwave  
Illumination  
Here

# Gravity Experiment

---

- Make, trap and stack antihydrogen ( $\sim 50$  stacks)
- Ramp down long octupole
- Measure magnetic field at full trapping current + bias
  - Under Mirrors A and G
- Ramp down to  $\sim 10$ 's Gauss residual trap ( $\sim 18$  s)
  - Maintain constant magnetic bias (current control)
- Identify up/down annihilation events along the way.
- Measure magnetic field again (check bias)
- Repeat for many magnetic biases
  - Statistics collected for  $\sim 300$  Hbar per bias ( $\sim 7$  trials each bias)

# Annihilation events

- Escaping antihydrogen leave going Up or Down

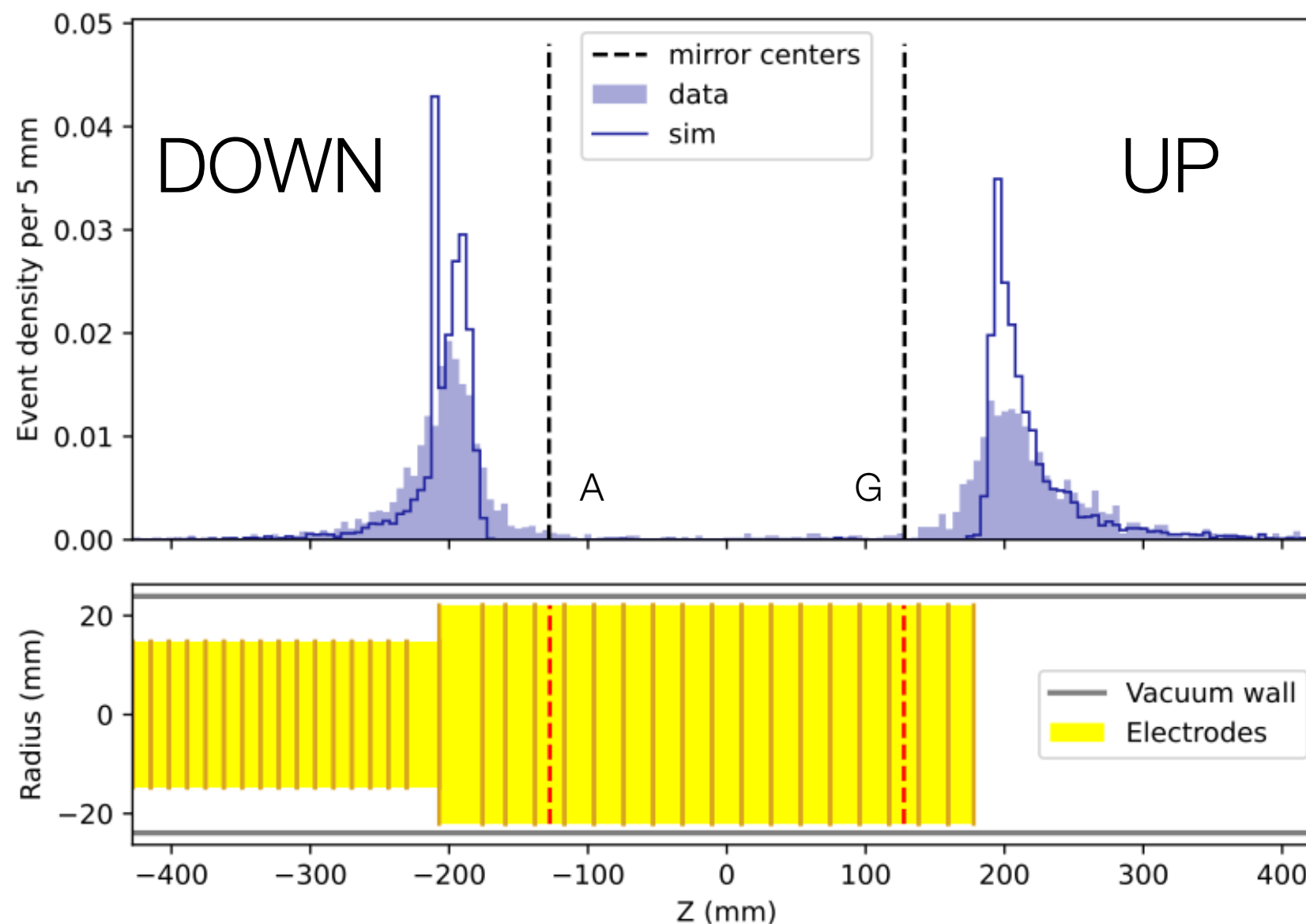

# Release for different biases

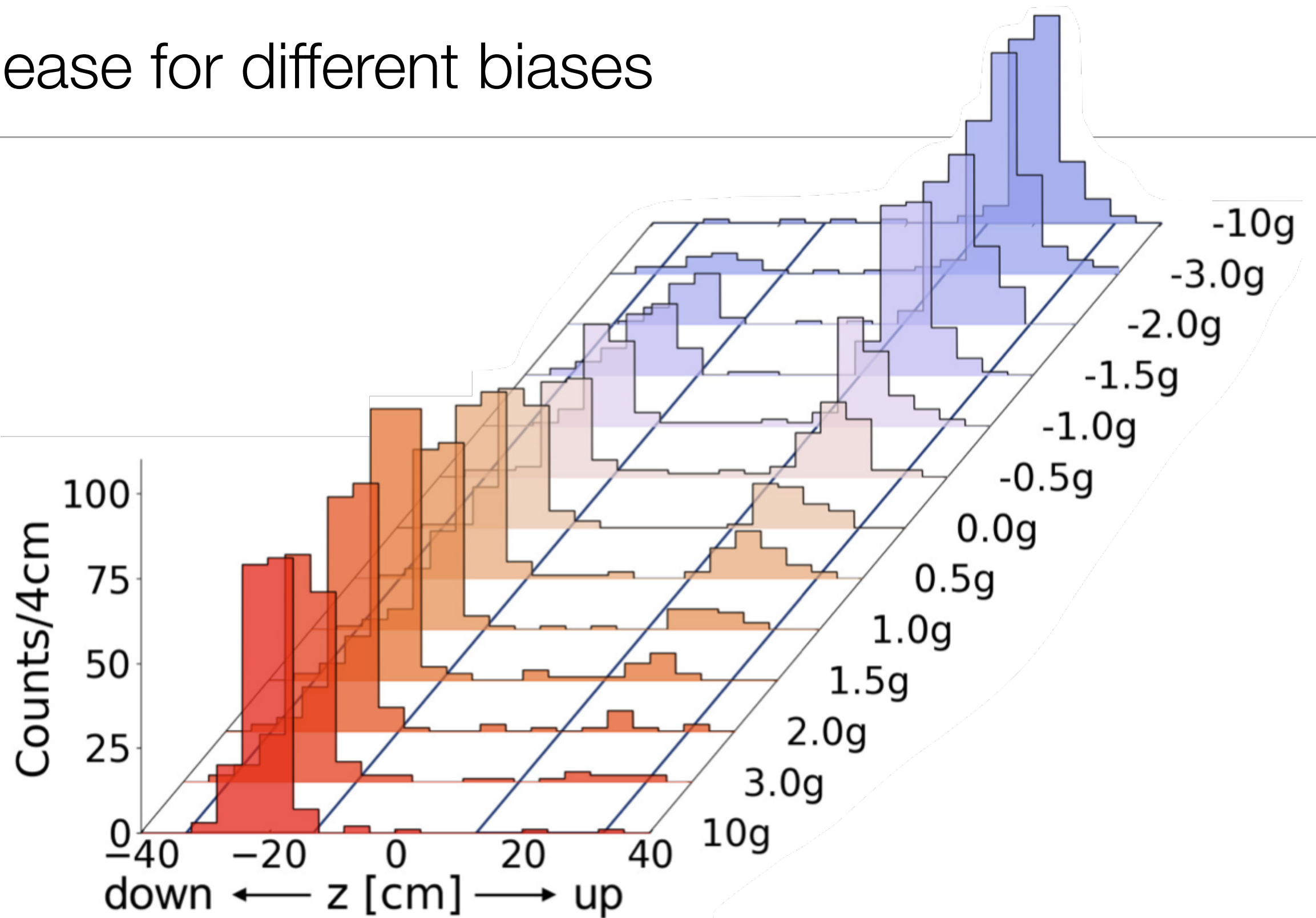

# Release for different Biases

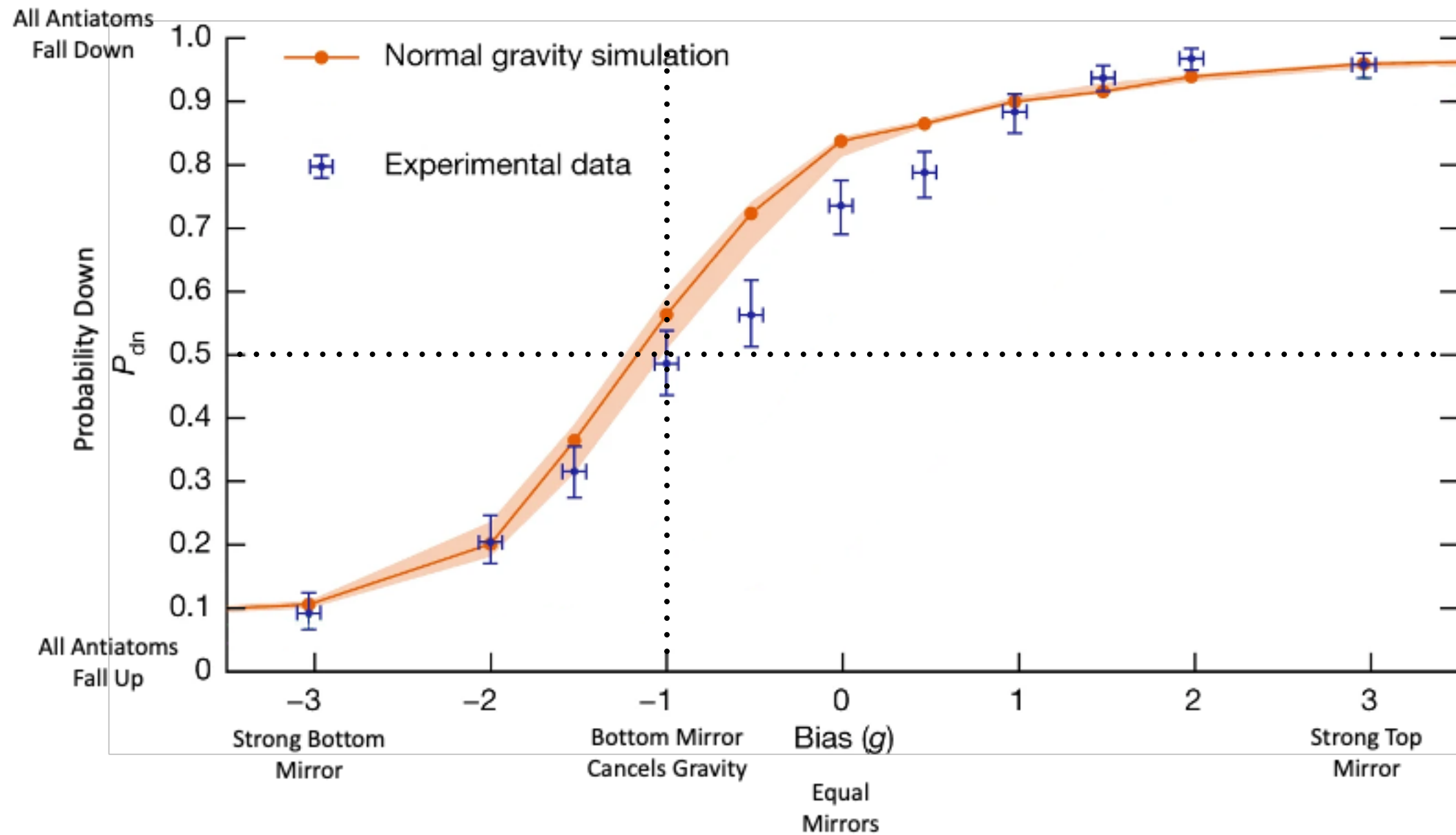
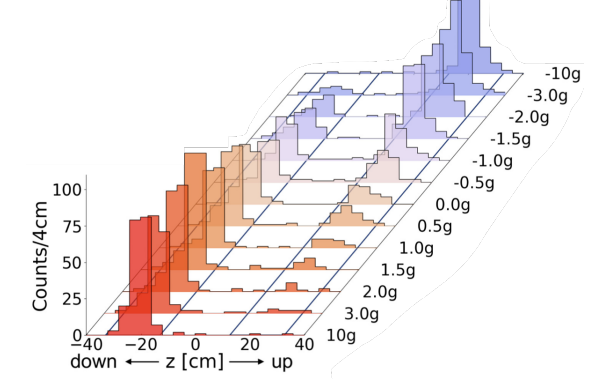



# Release for different Biases

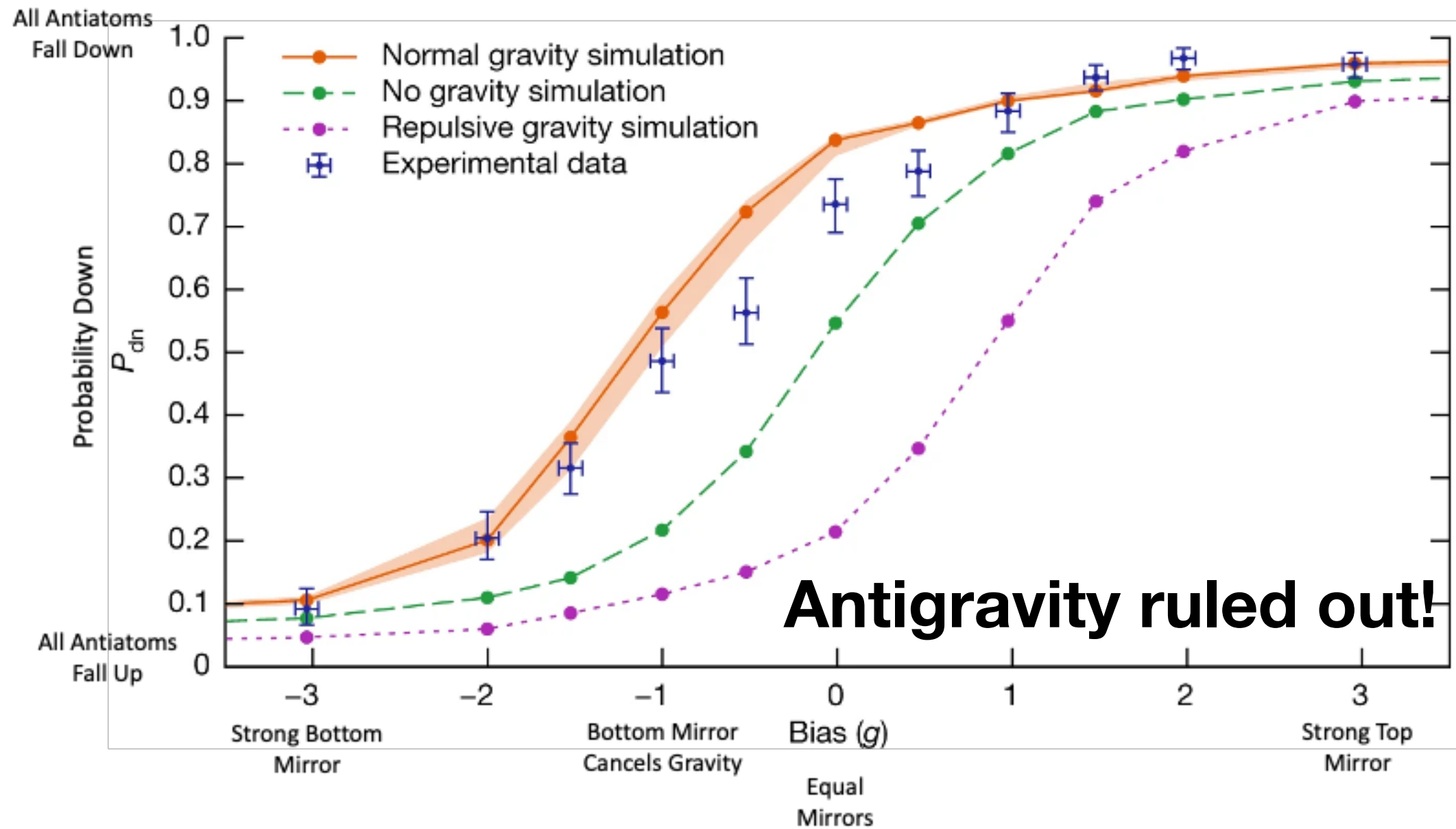
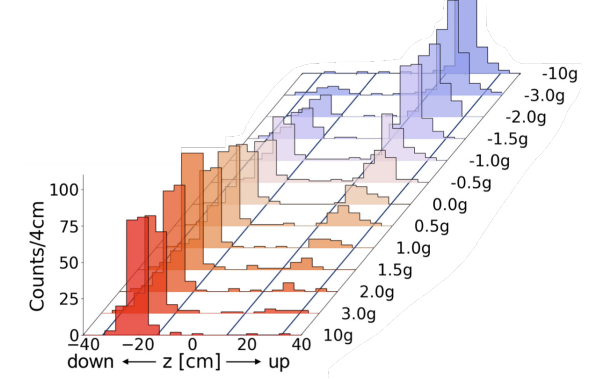

# Calculating Antimatter g

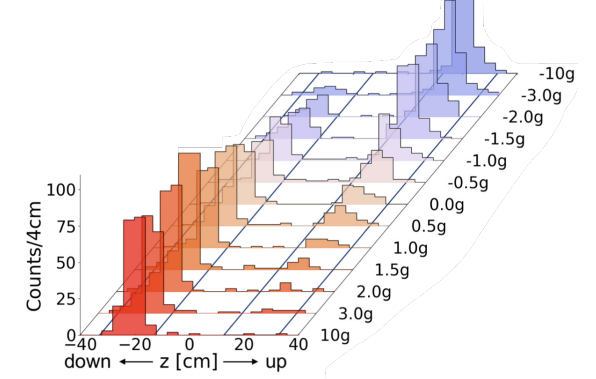

- Perform numerous simulated accelerations
- Find best fit to data

$$\bar{g} = [0.75 \pm 0.13 \text{ (statistical + systematic)} \pm 0.16 \text{ (simulation)}] g$$

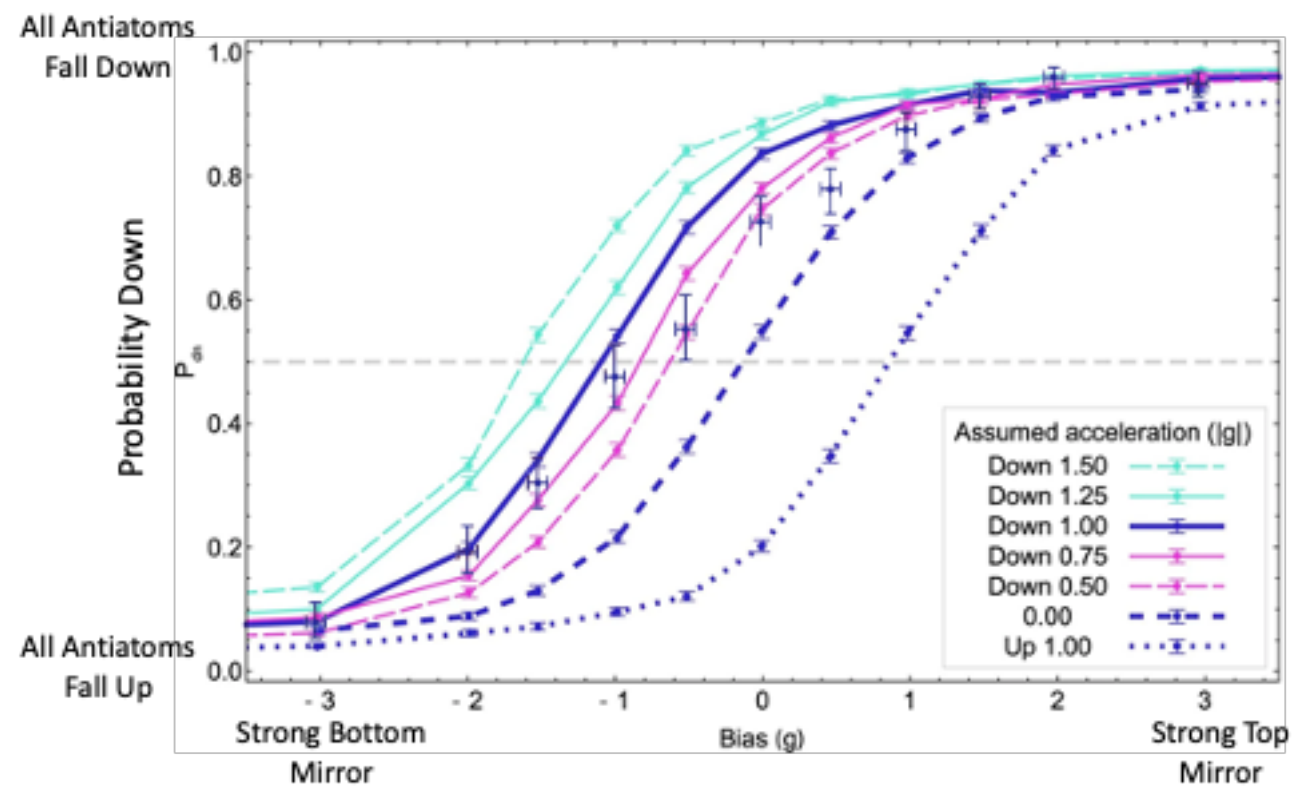

# Limits to the measurement: field measurements

---

- Need to model both controlled currents, and uncontrolled persistent currents.
- Induced persistent currents:  $\sim 10$  Gauss on axis (*recall, 1 g bias is  $\sim 4.5$  G!*)

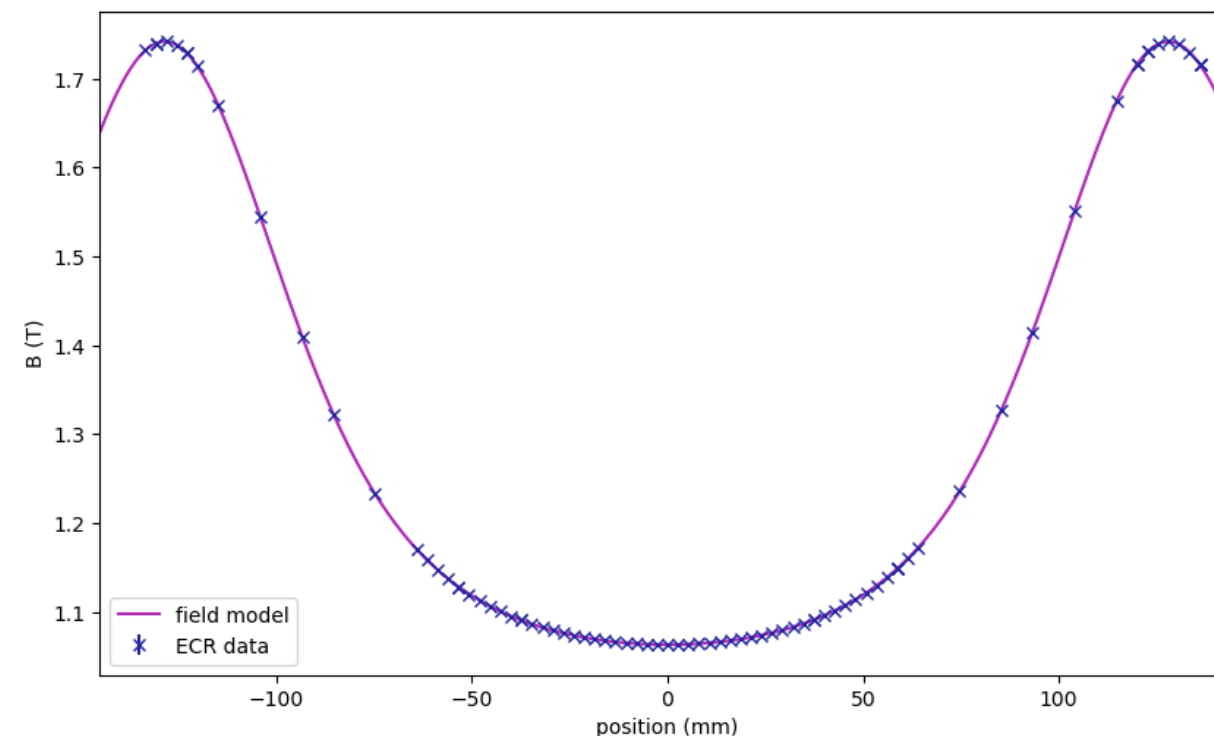

# Limits to the measurement: field measurements

- Persistent currents contribute significantly to the field
- These currents decay in time (ECR)
- No significant *difference* in the decay of Mirrors A, G
  - Largest observed difference used for error

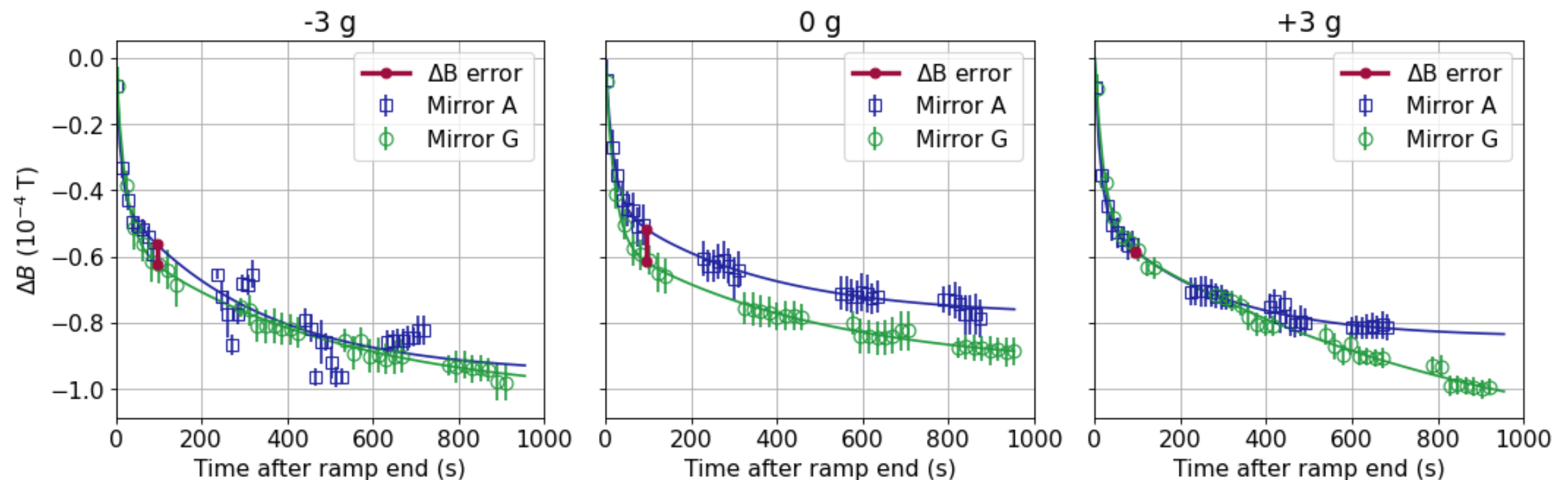

# Limits to the measurement: field measurements

- Persistence currents during ramp
- Imaged Electron Magnetron Frequency: time-resolved B-field during a given release

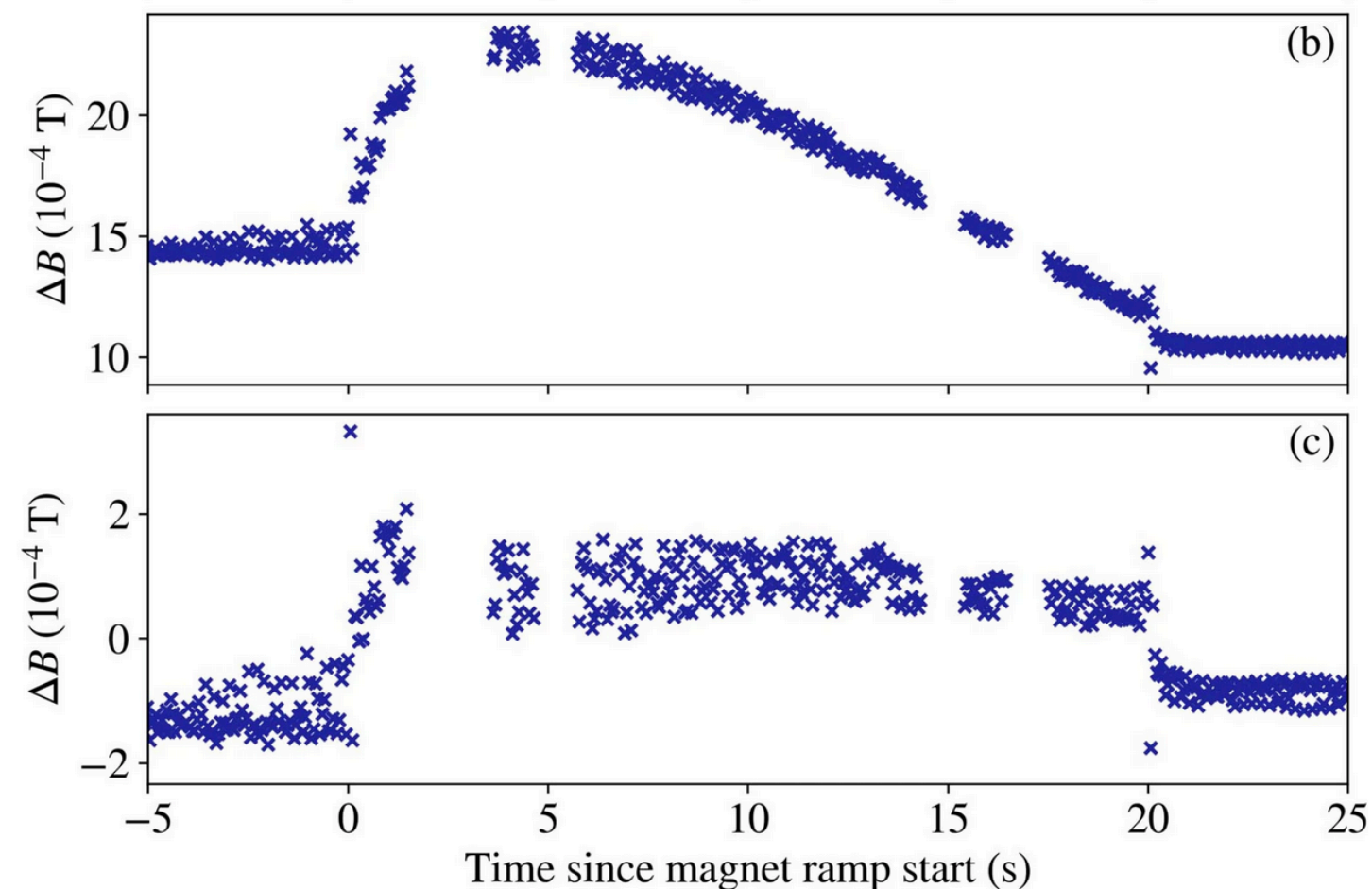

# Limits to the measurement: Bias time dependence

- Experiment bias: linear *current difference*
- Geometry of magnets + persistence currents results in *a time-dependent bias*
- Field for simulation
- Weighted mean: *“bias label”*

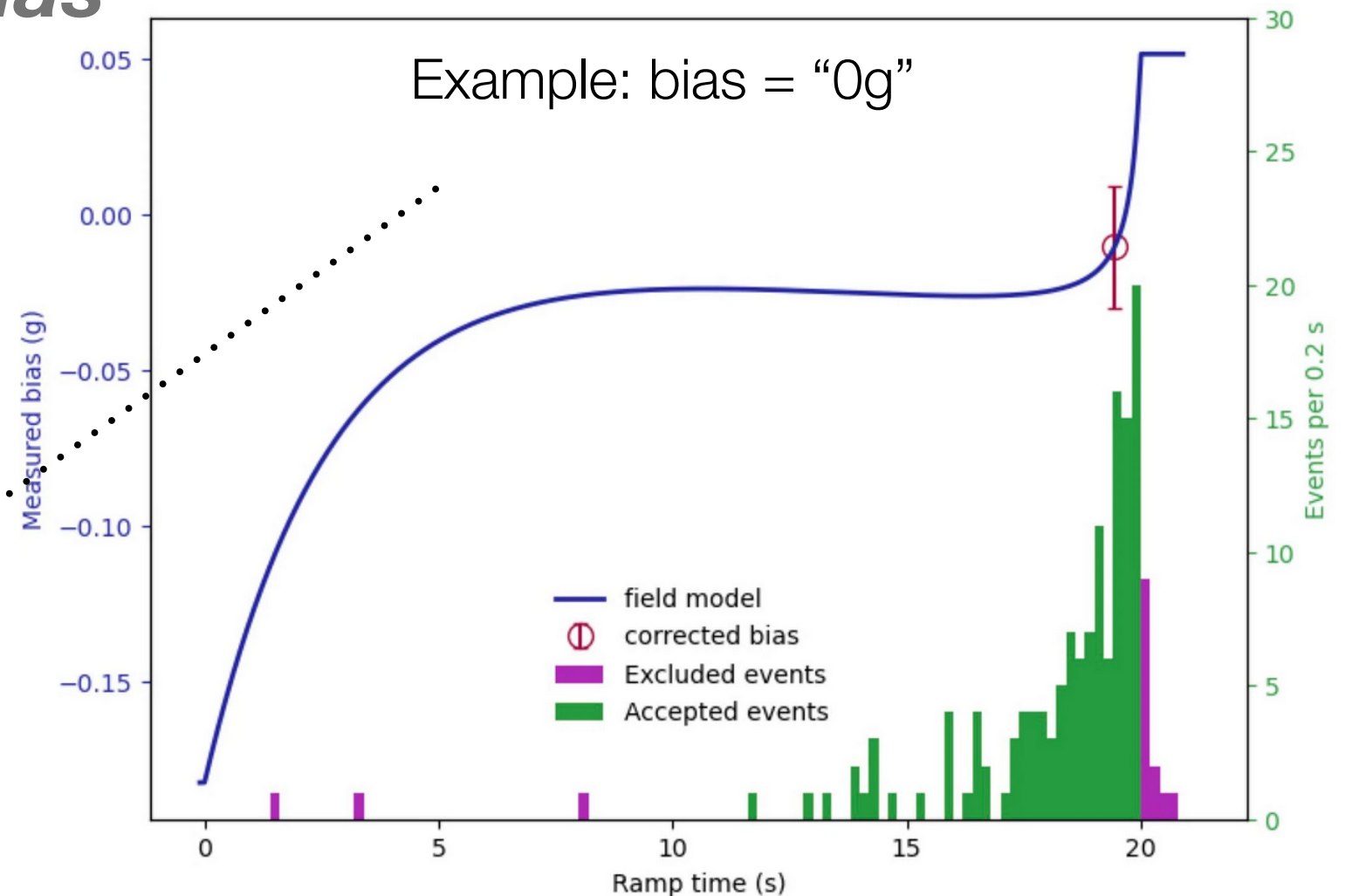
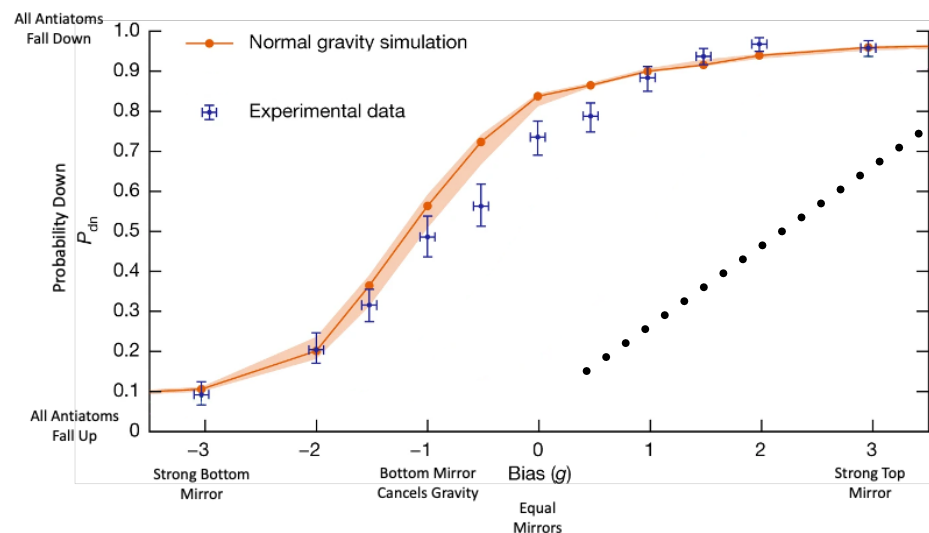



# Uncertainty tables

---

- Many aspects contribute to error.
- Largest (0.16 g) is uncertainty from estimated off-axis asymmetry in the octupole field (unmeasured)

Uncertainty	Magnitude (g)
ECR spectrum width	0.07
repeatability of ( $B_G - B_A$ )	0.014
peak field size and z-location fit	0.009
field decay asymmetry (A to G) after ramp	0.02
bias variation in time	0.02
field modelling	0.05

	Uncertainty	Magnitude (g)
Statistical and Systematic	Finite data size	0.06
	Calibration of the detector efficiencies in the up and down regions	0.12
	Other minor sources	0.01
Simulation model	Modelling of the magnetic fields (on-axis and off-axis)	0.16
	Antihydrogen initial energy distribution	0.03

# Future prospects with ALPHA-g: 1% Measurements

- Make the release curve steeper

Simulated Release Experiments

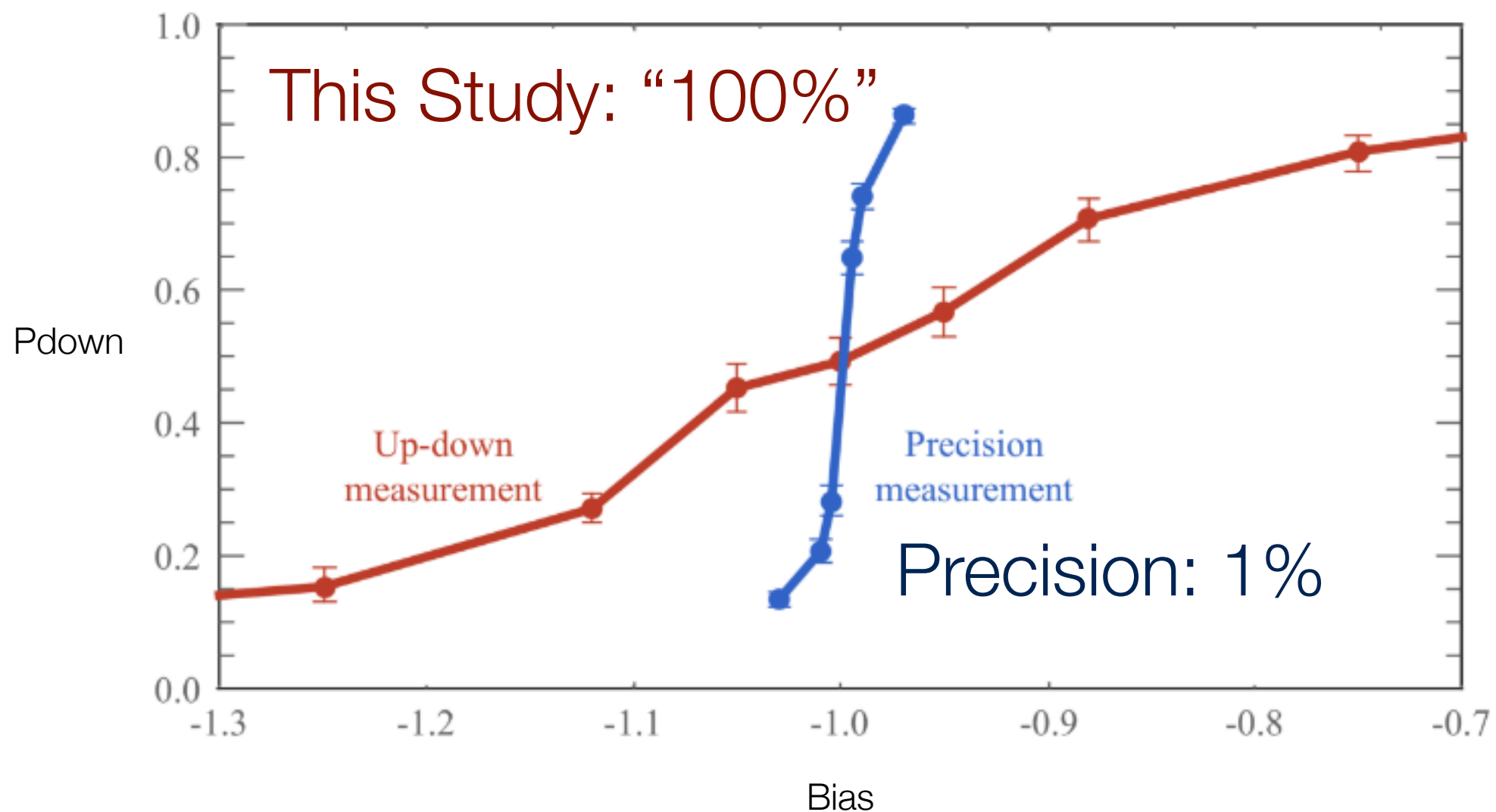

# Future prospects with ALPHA-g: 1% Measurements

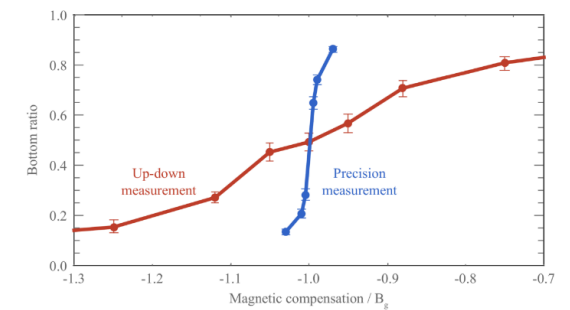

- Precision region
  - symmetrizes superconducting material
  - + detection geometry
  - Improves shape of applied bias potential

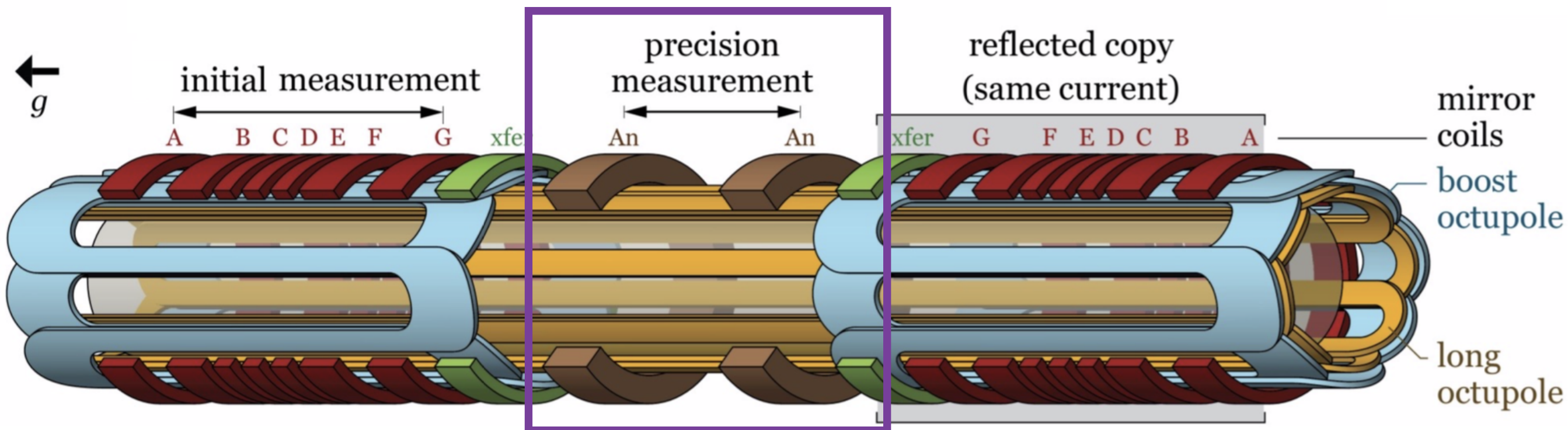

# Future prospects with ALPHA-g: 1% Measurements

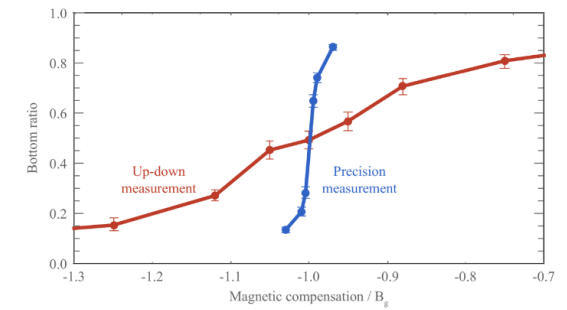

- Generally, escape bias is a function of radius
  - *Broadens and shifts release curve*
- Additional correction coils to “flatten” escape bias

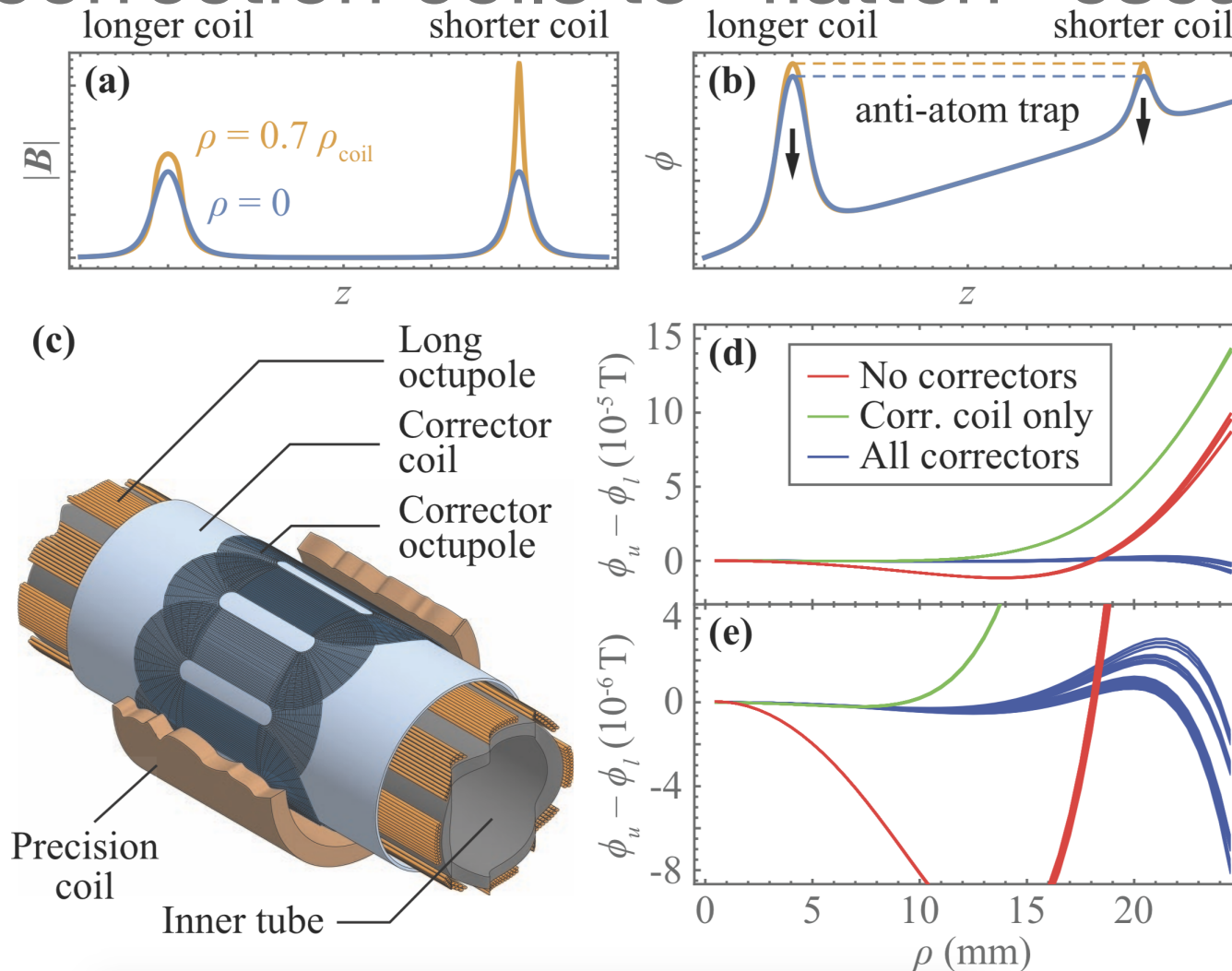

# Future prospects with ALPHA-g: 1% Measurements

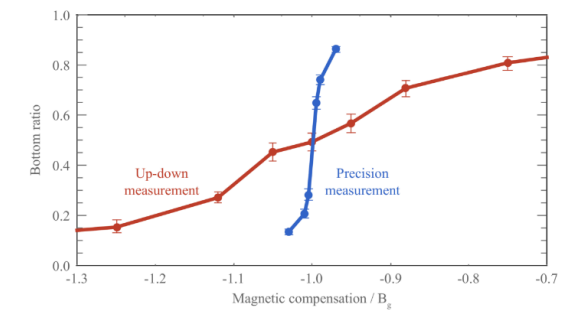

- Improve distribution: Doppler Laser Cooling
- Slower atoms more sensitive to potential
- avoid off-axis fields
- 500 mK > 20 mK > 300  $\mu$ K

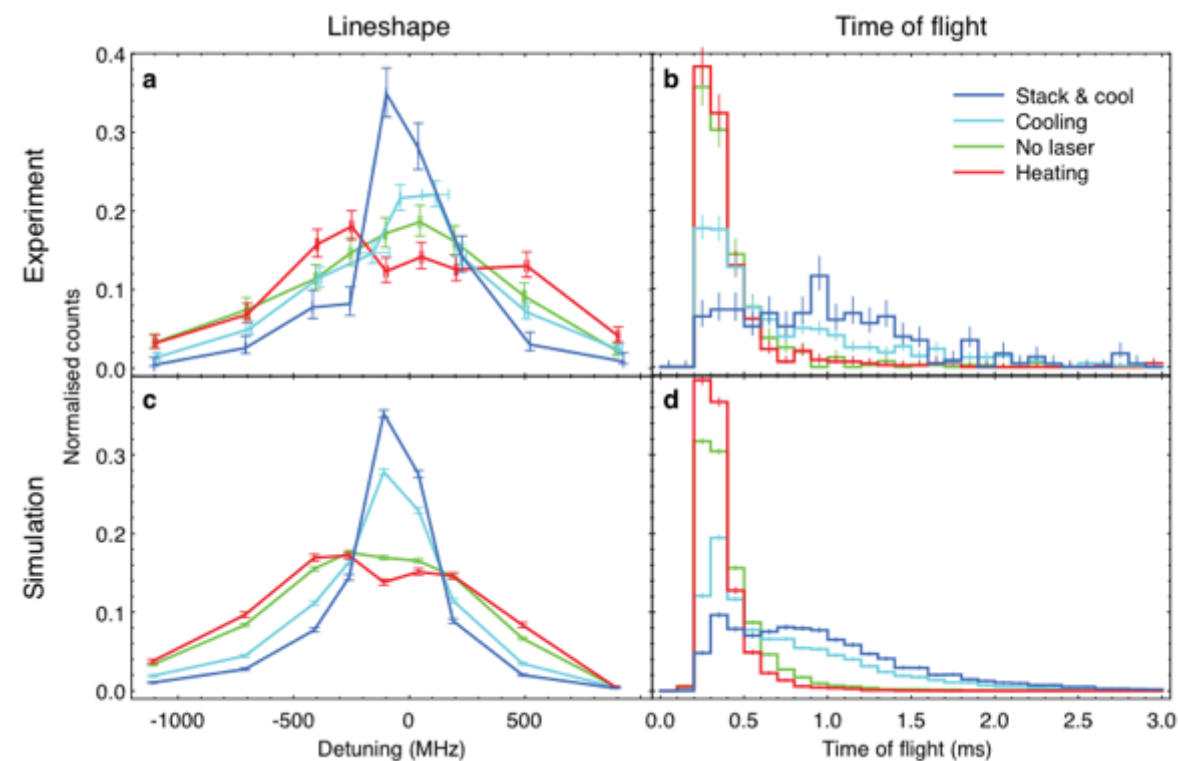

C. J. Baker, *et al.* "Laser cooling of antihydrogen atoms." *Nature* **592**, 35-42 (2021).



# Beyond 1% with trapped antihydrogen atoms

- Antimatter interferometry for gravity measurements
- Colder atoms
- Different geometry
- Challenging Lasers
- ... towards ppm precision with trapped atoms

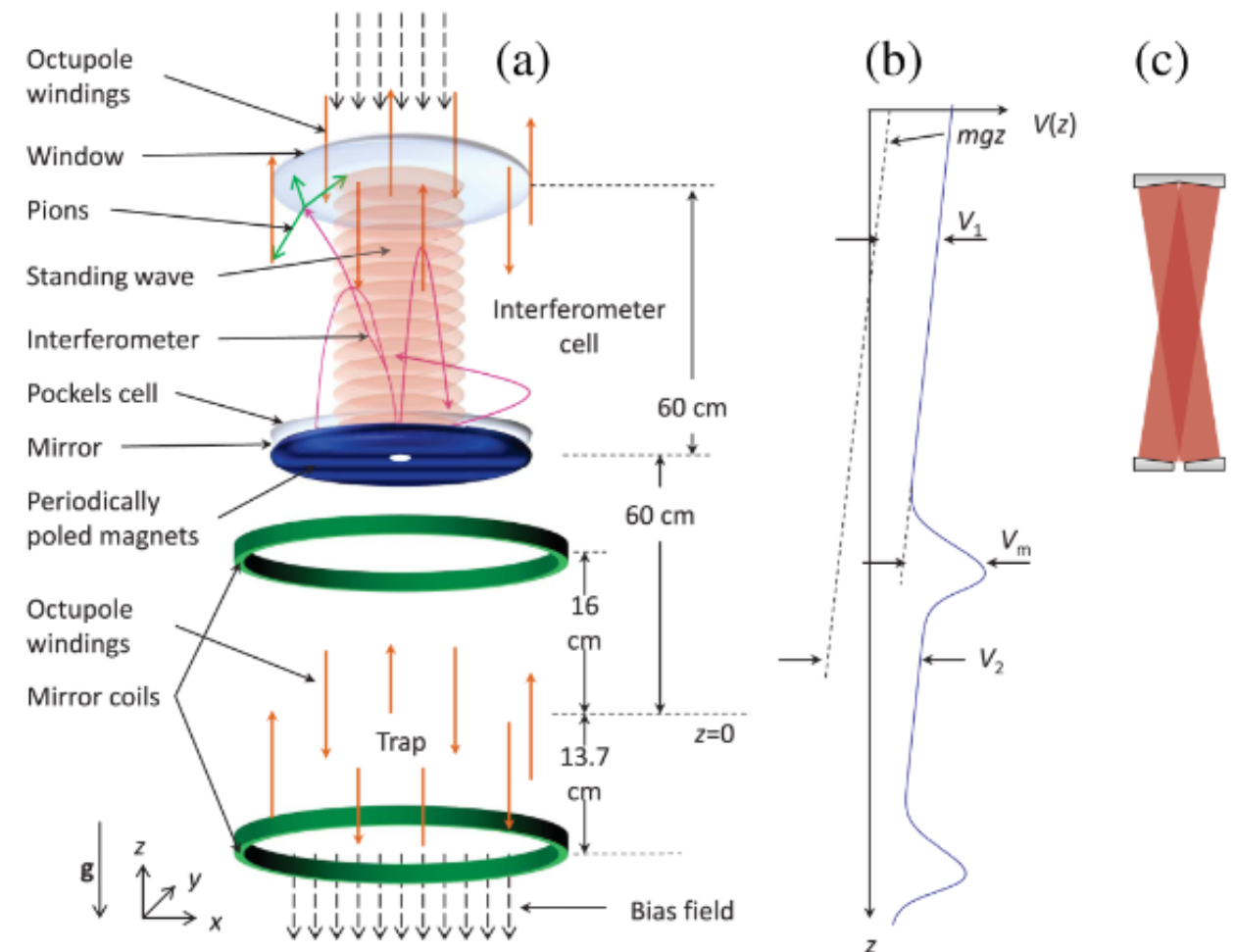

P. Hamilton, A. Zhmoginov, F. Robicheaux, J. Fajans, J. S. Wurtele, and H. Müller  
Phys. Rev. Lett. 112, 121102



# Thanks for your attention!

Anti-Apple

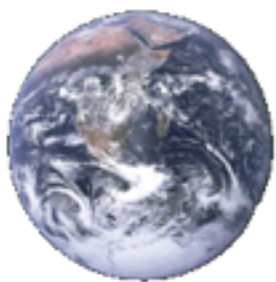

Earth



# Antihydrogen Laser Cooling: Closed transitions

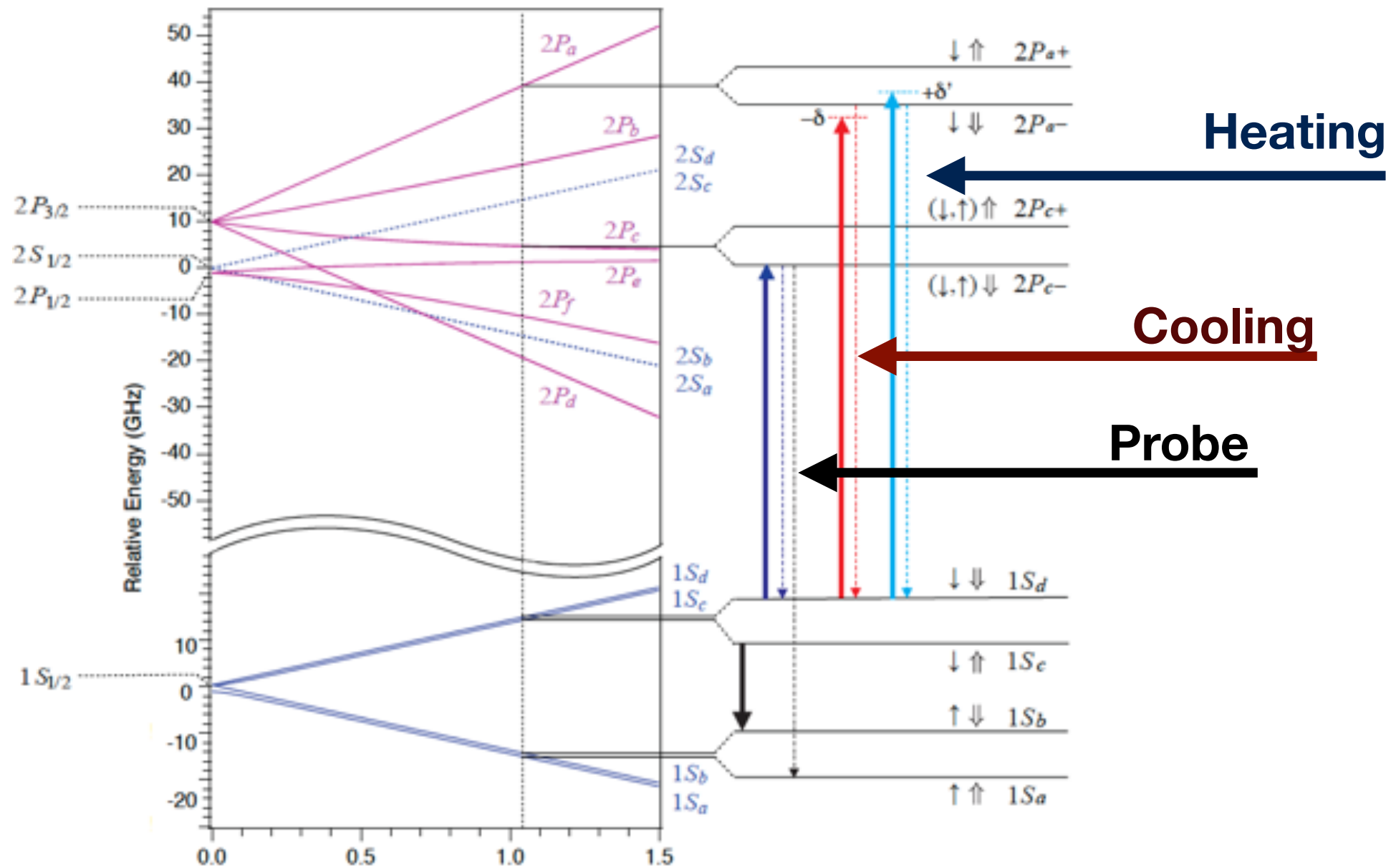

# Antihydrogen Laser Cooling

- Stack antihydrogen for **hours**
- Clean **c**-state atoms (microwaves)
- Illuminate  $1S_d \leftrightarrow 1P_a$  for **hours**
- Probe using  $1S_d \leftrightarrow 2P_c$  transition: measure line shape for **hours**
- Measure time of flight for atoms hitting the wall
- **Conditions:**
  - red detuning, blue detuning, no laser, cooling during stacking

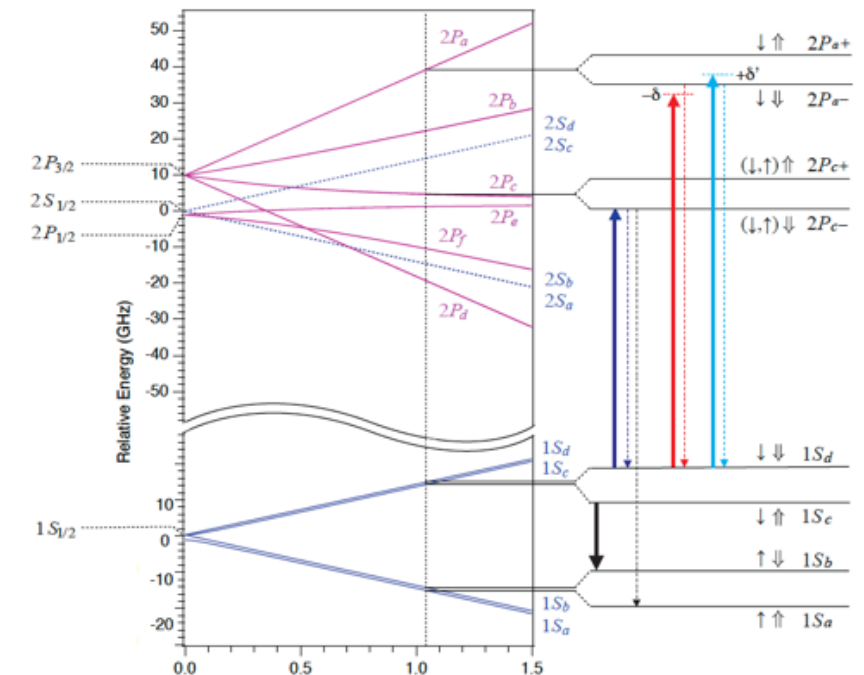



# Antihydrogen ground state hyperfine spectrum:

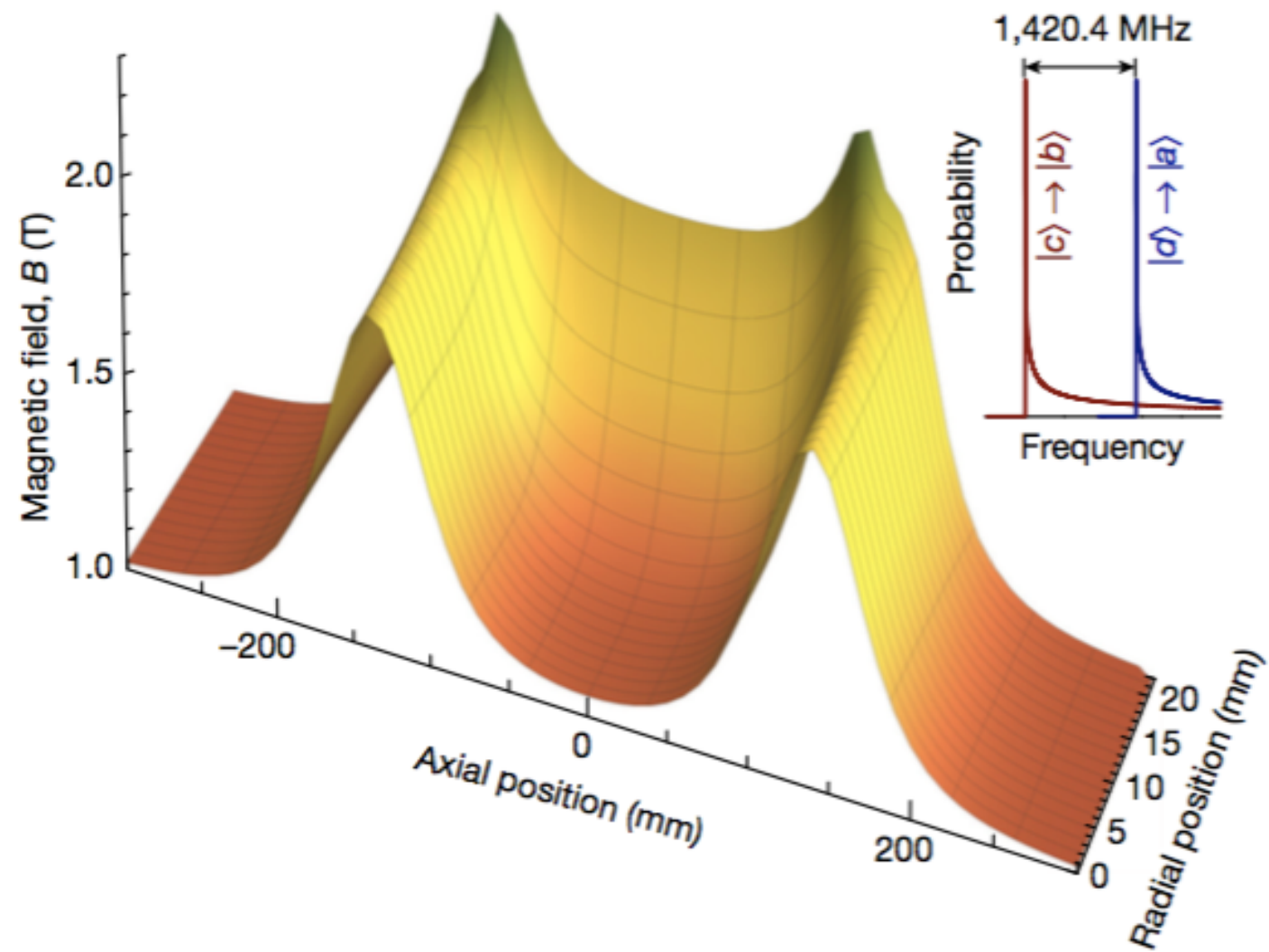
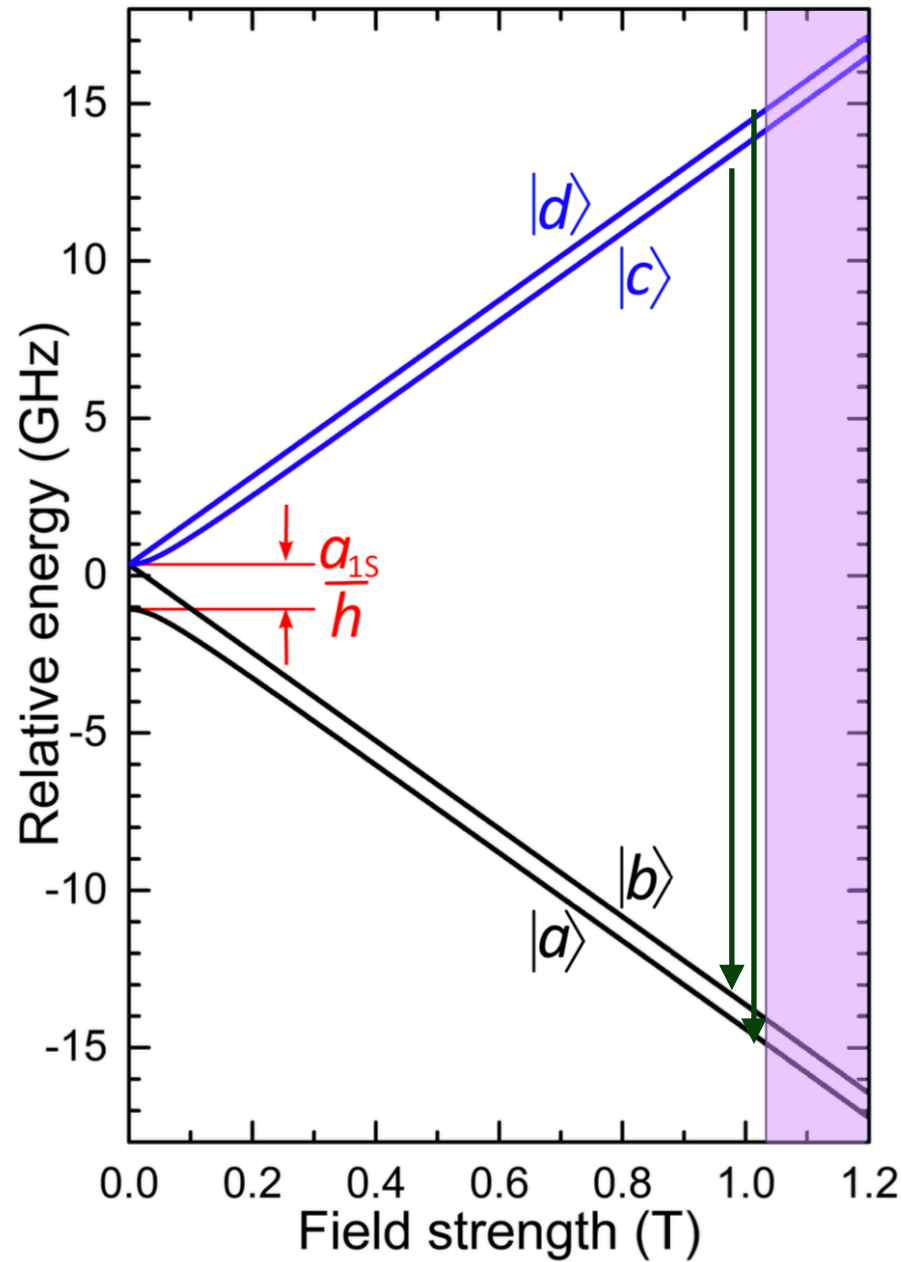

# Antihydrogen hyperfine spectrum

Illuminate trap with successive microwave frequencies  $\sim 29$  GHz  
Count annihilations in each frequency bin  
Compare with atomic Montecarlo simulation

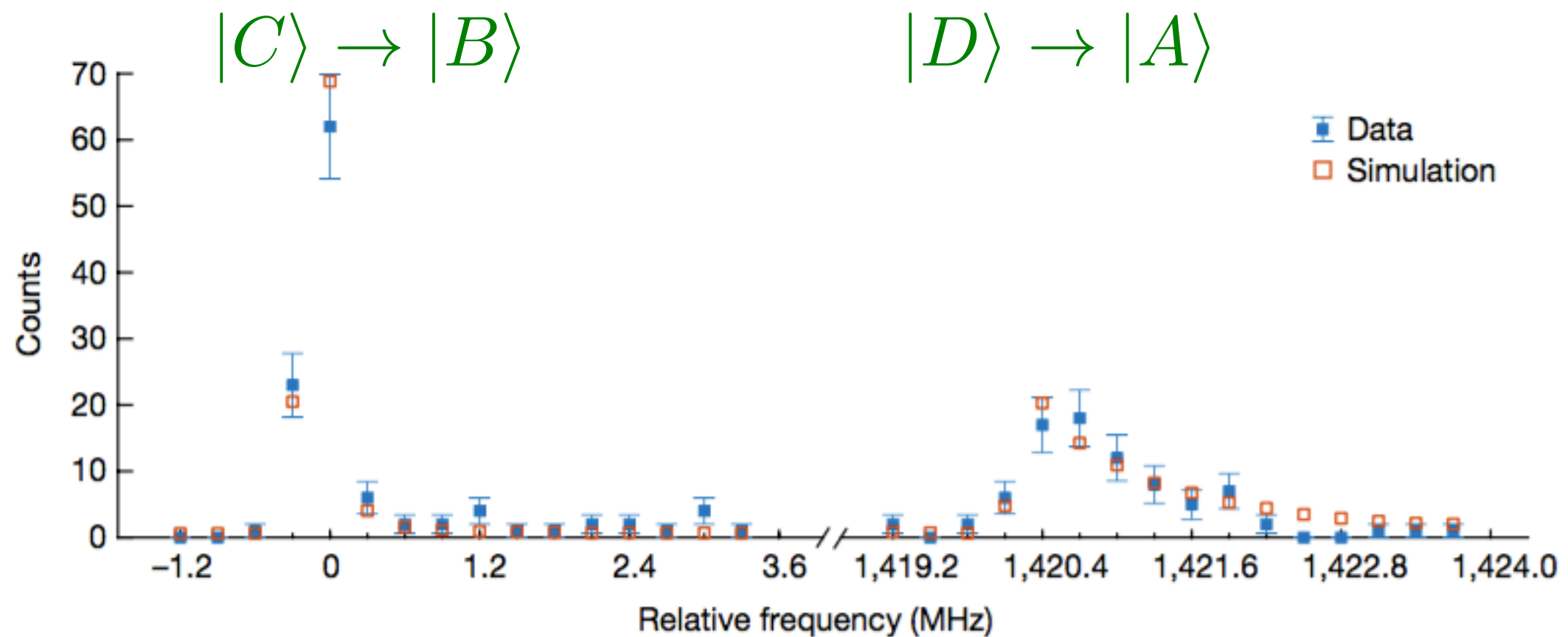

$1,420.4 \pm 0.5$  MHz

Ahmadi, M. *et al.* "Observation of the hyperfine spectrum of antihydrogen." *Nature* 548, 66–69 (2017).

# Limits to the measurement: Patch “Magnetronometry”

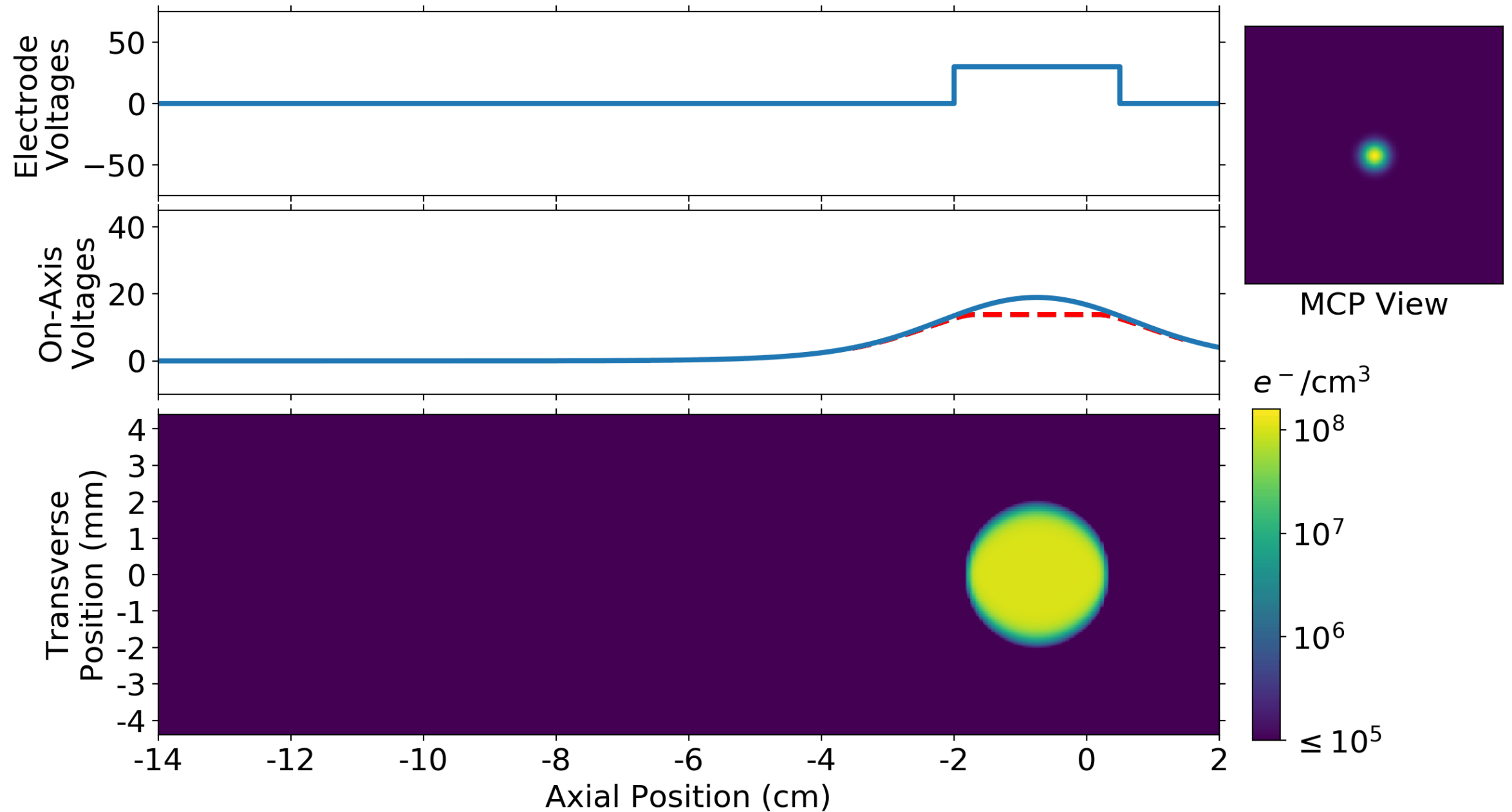



# Current control

	<b>Supply (maximum Operating Current)</b>	<b>Current Programming Resolution (mA)</b>	<b>Programming Resolution (g)</b>	<b>Current noise (mA rms)</b>	<b>Bias field from current noise (g)</b>
Long Octupole (LOc)	Sorensen SGA 10-1200 (830 A)	37 (analog)	N/A	0.5	N/A
Bottom Octupole (OcB)	Sorensen SGA 10-1200 (830 A)	37 (analog)	N/A	0.6	N/A
Mirrors (MAG)	CAENELS FAST-PS-1K5 (70 A)	3.1 (analog)	0.06	0.7	< 0.001
Mirror G bias (MGDiff)	Kepeco BOP 20-10 (3 A)	0.34 (analog)	0.007	0.4	< 0.001
External Solenoid Main Coil	2x CAENELS FAST-PS-1K5 (191 A)	0.8 (digital)	0.04	1.8	0.01
External Solenoid Shim Coil	CAENELS FAST-PS 1020-200 (5A)	0.1 (digital)	N/A	1.5	0.003