



Science and  
Technology  
Facilities Council

Daresbury Laboratory

*'Particle accelerators are built for the sole purpose of endowing nuclear particles with large quantities of kinetic energy' – John Livingood*

# CI-ACC-101.1

## Particle Accelerators – History and Principles

Hywel Owen, UKRI-STFC-ASTEC-AP  
Accelerator Science and Technology Centre  
[hywel.owen@stfc.ac.uk](mailto:hywel.owen@stfc.ac.uk), @hywelowen

17<sup>th</sup> October 2022  
Cockcroft Institute Lecture Series

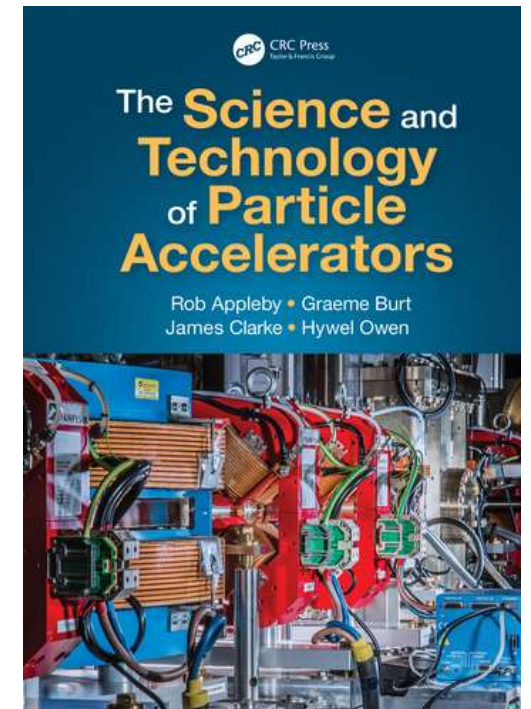

# Radioactivity: Becquerel + 2 Curies

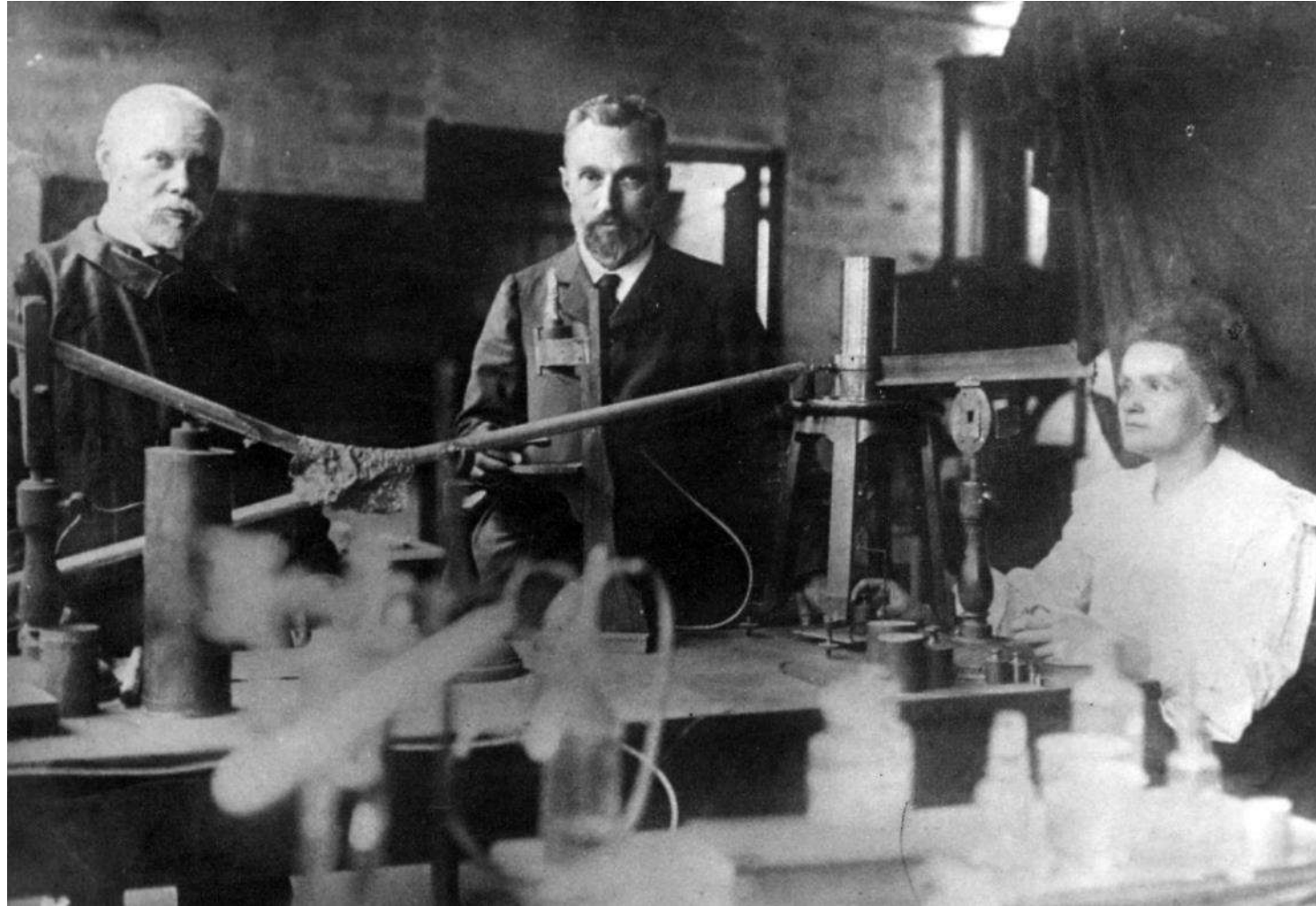

# Splitting the atom - Manchester

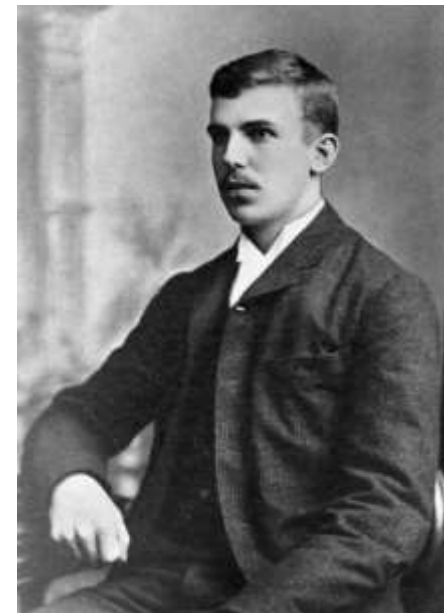
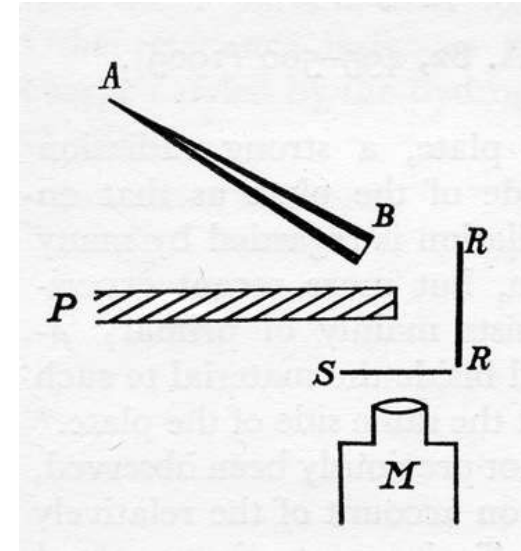

*"it has long been my ambition to have available for study a copious supply of atoms and electrons which have an individual energy far transcending that of the alpha- and beta-particles from radioactive bodies"*

# William Crookes

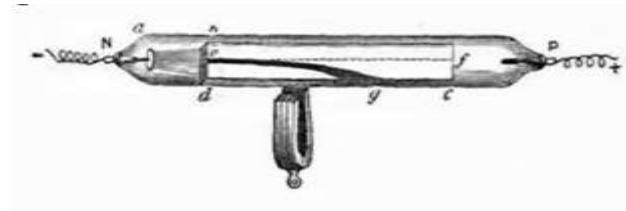
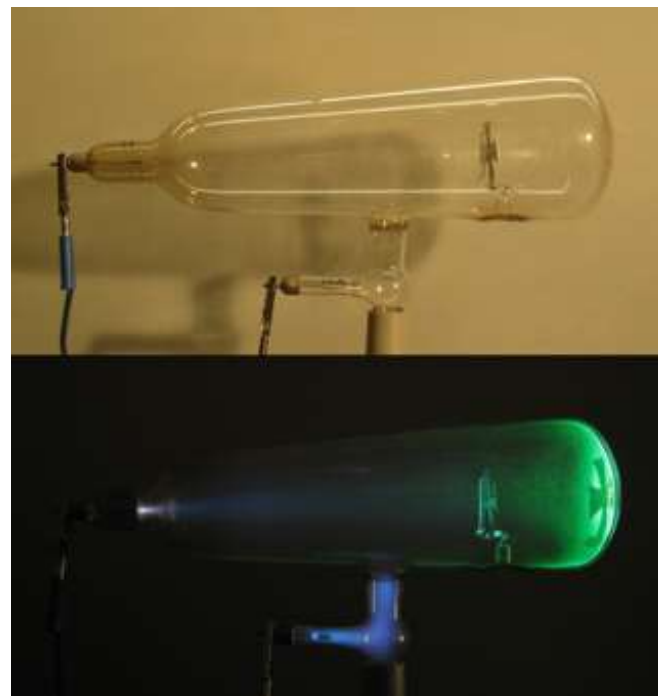

$$\vec{F} = q\vec{E} + q\vec{v} \times \vec{B}$$

# Walton, Rutherford, Cockcroft

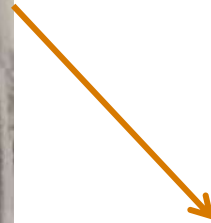

- In 1928, George Gamow proposed that alpha particles could tunnel through the nuclear energy barrier. John Cockcroft saw Gamow give a lecture in January 1929 at the Cavendish laboratory (Cambridge), and realised that voltages of only a few hundred keV could deliver nuclear transmutations, rather than the many MeV they previously thought was needed.
- Rutherford agreed with Cockcroft's calculations, and convinced Walton to abandon his linear accelerator idea. Using a £1000 university grant they bought a 300 kV transformer which they then rectified to DC. A small beam of low-energy protons was then accelerated downwards to 280 keV and into some light targets (Li and Be). However, this didn't work.
- Cockcroft invented a voltage multiplier to obtain up to 700 keV, which was enough. The atom was split, making alpha particles that Walton observed while sitting in the lower observation cabin.



Walton and the machine used to "split the atom"

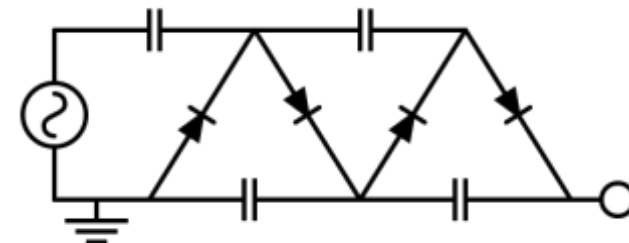

# DC Acceleration

Cockcroft-Walton  
 $\text{Li} + \text{p} \rightarrow \text{He} + \text{He}$

Robert Van de Graaff's Patent

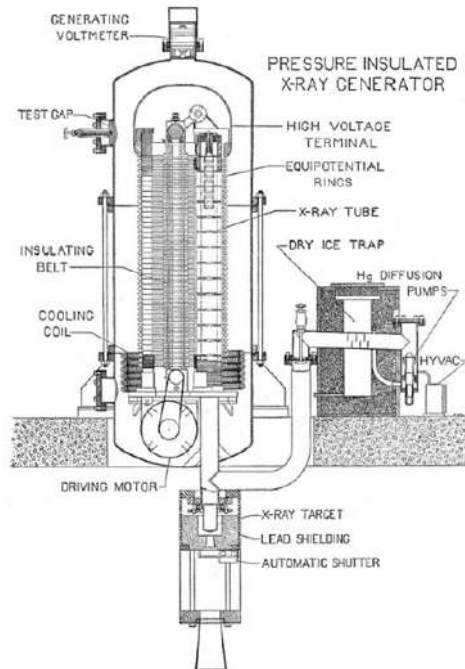

Walton and the machine used to "split the atom"



THE GENERATOR IN THE HANGAR AT ROUND HILL.  
 BMIT Museum - All rights reserved.

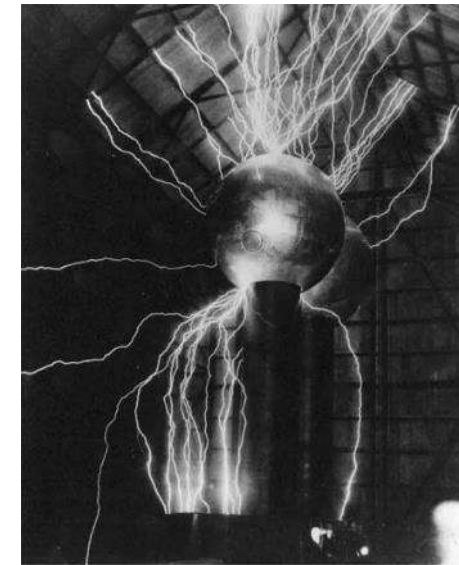

AT ROUND HILL SPARKING TO HANGAR (LONG EXPOSURE)  
 BMIT Museum - All rights reserved.

MIT Round Hill Van de Graaff



ORNL Tandem VdG

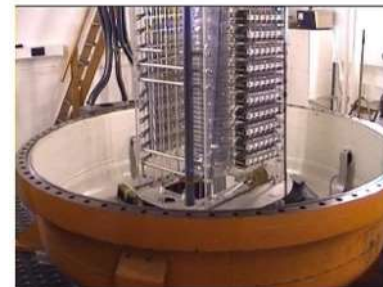
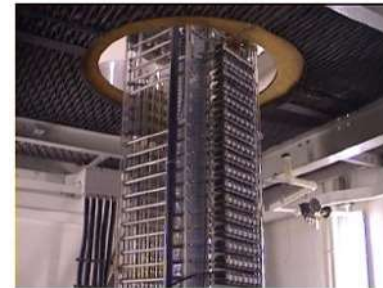

Birmingham dynamitron  
 3 MeV, 1 mA protons

# Daresbury VdG

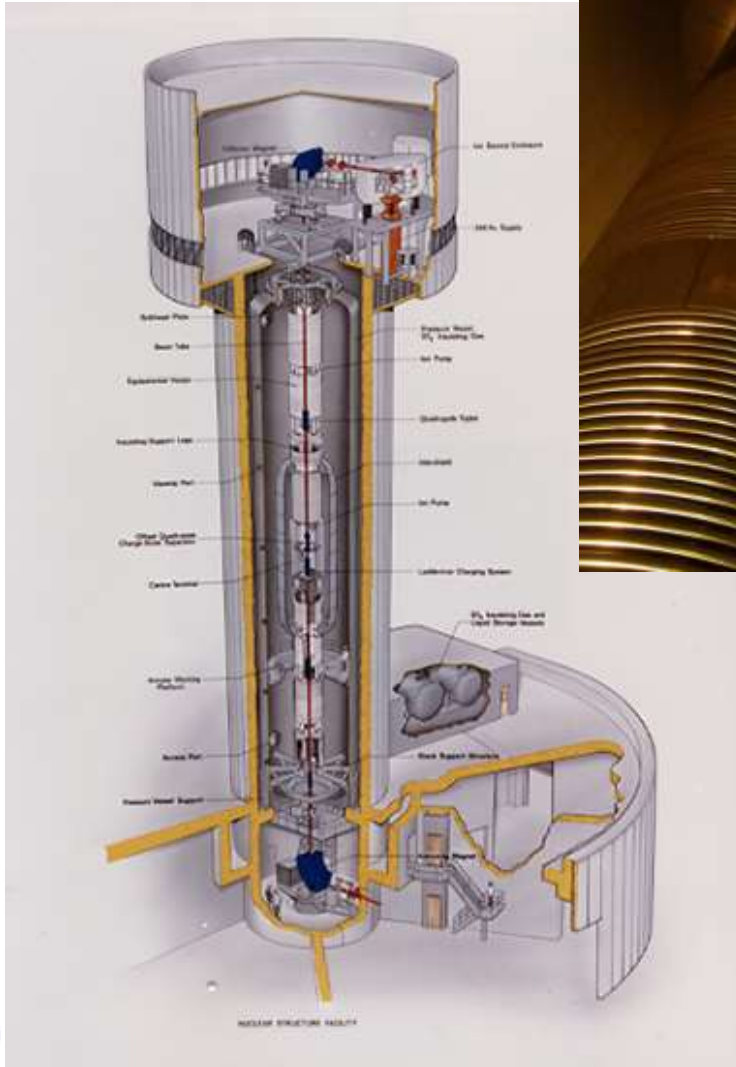

NSF: 20 MV Van de Graaff

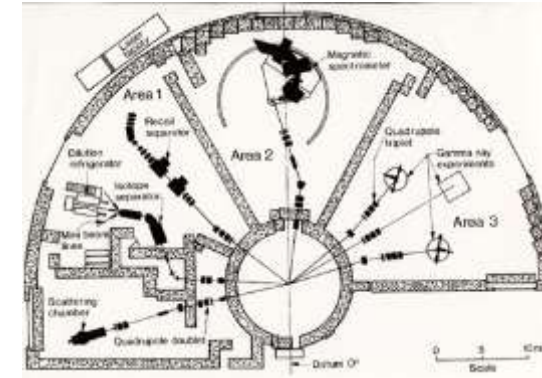

# Lorentz Force – the fundamental equation for accelerators

$$\mathbf{F} = e\mathbf{E} + e\mathbf{v} \times \mathbf{B}$$

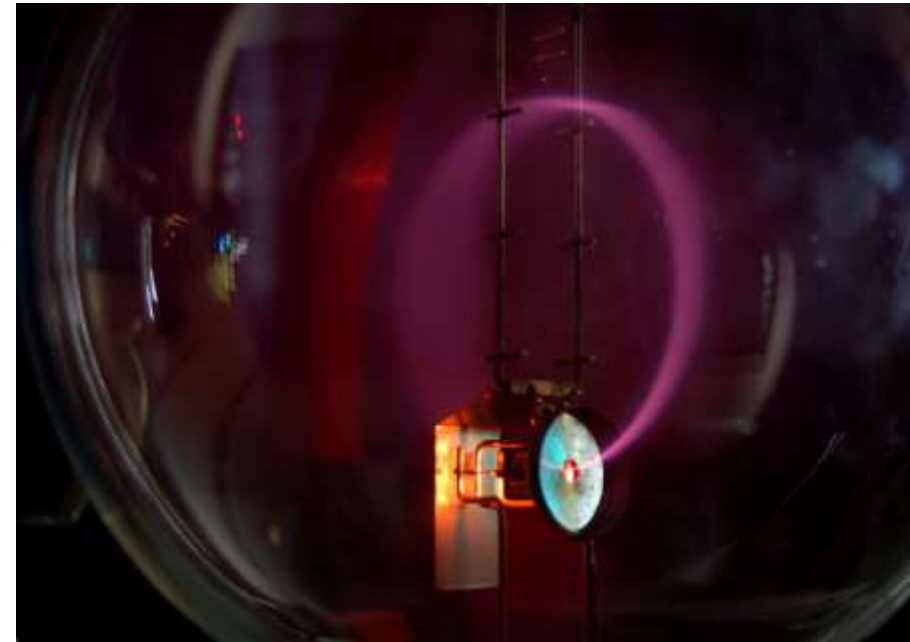
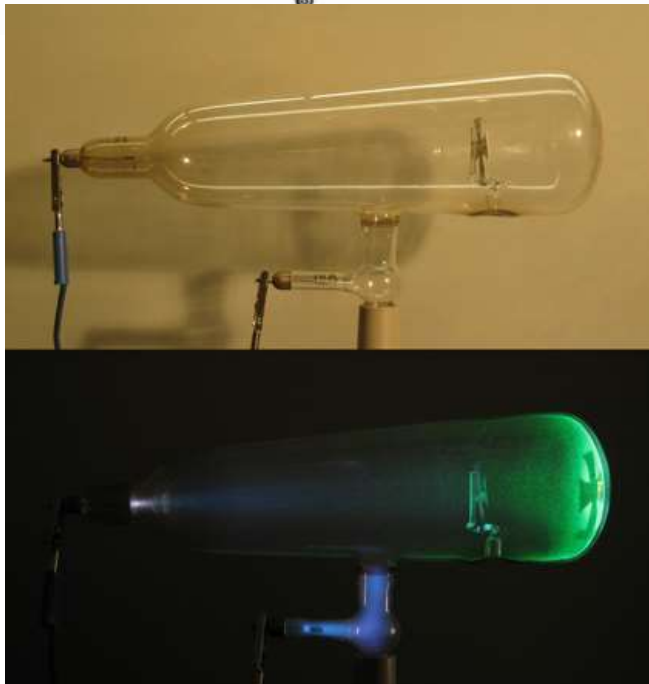
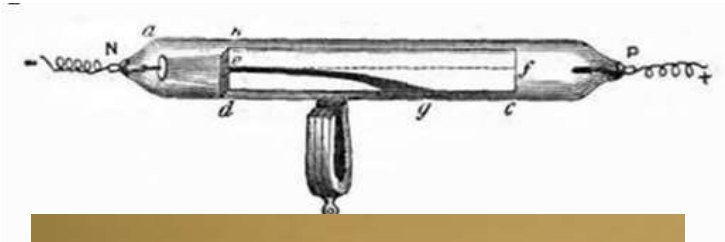



# Rolf Wideroe's Linac

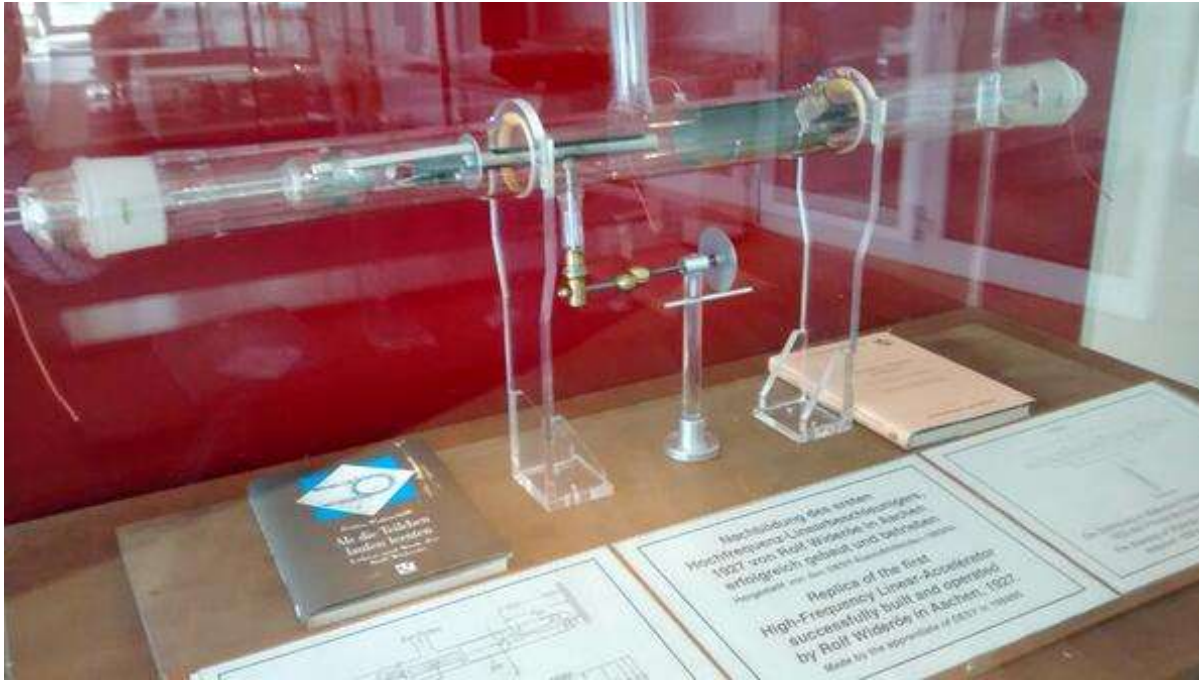

Replica of original linac, at National Physical Laboratory

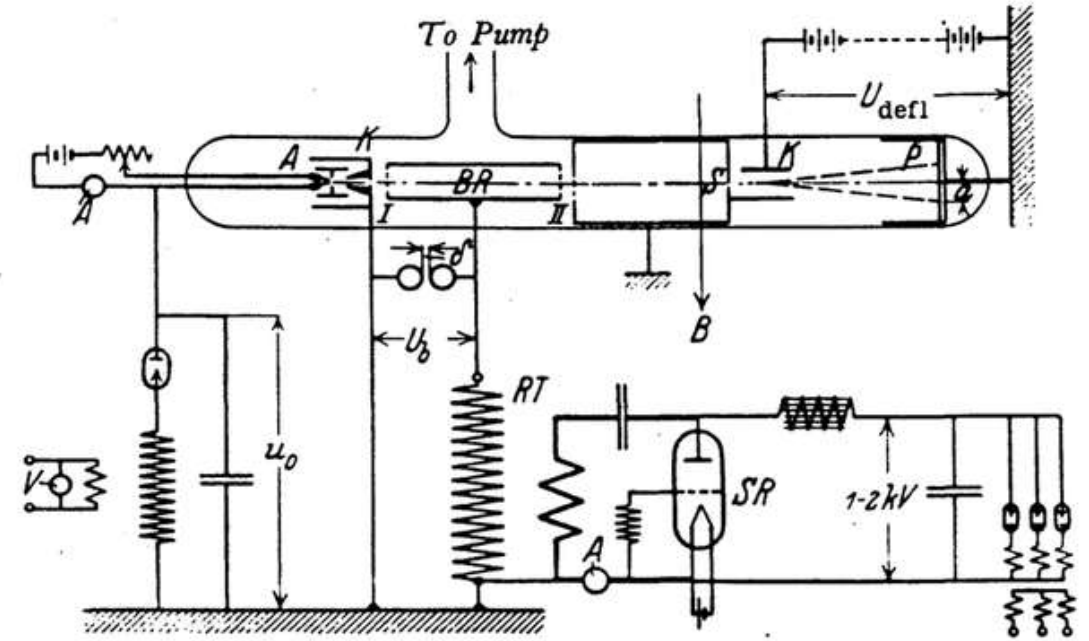

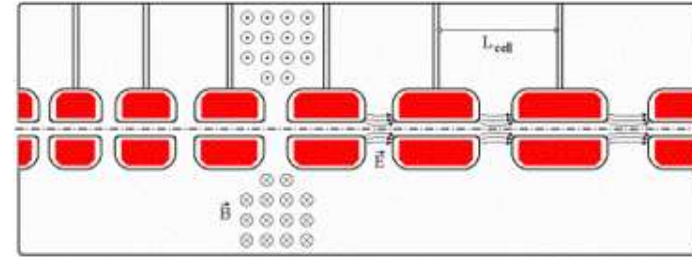
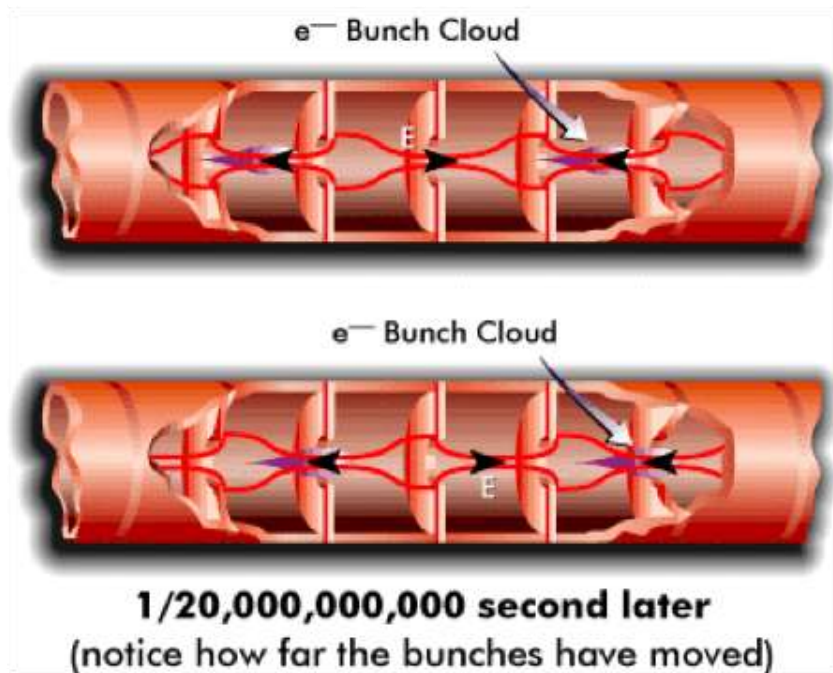

*Alvarez structure  
(with drift tubes)*

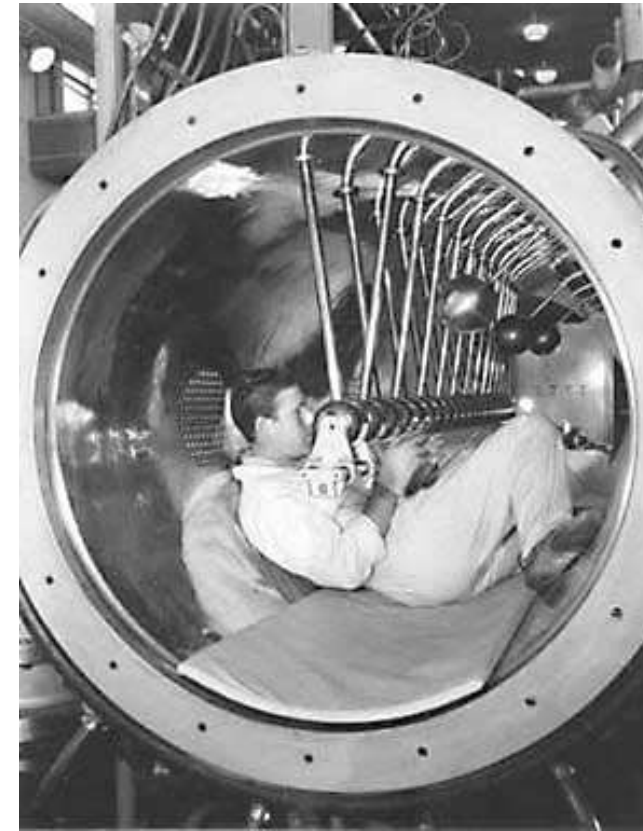

# Bill Hansen and the 1 MeV Linac, 1947 (6 MeV)



Proposed the cavity resonator  
for acceleration

(beware of beryllium)



Harry Kaplan  
Radiotherapy pioneer



Gordon Isaacs, 1957  
The first external-beam radiotherapy patient

# Chadwick apparatus – discovery of the neutron



Chadwick and Cockcroft,  
At Daresbury 20<sup>th</sup> Oct 1966

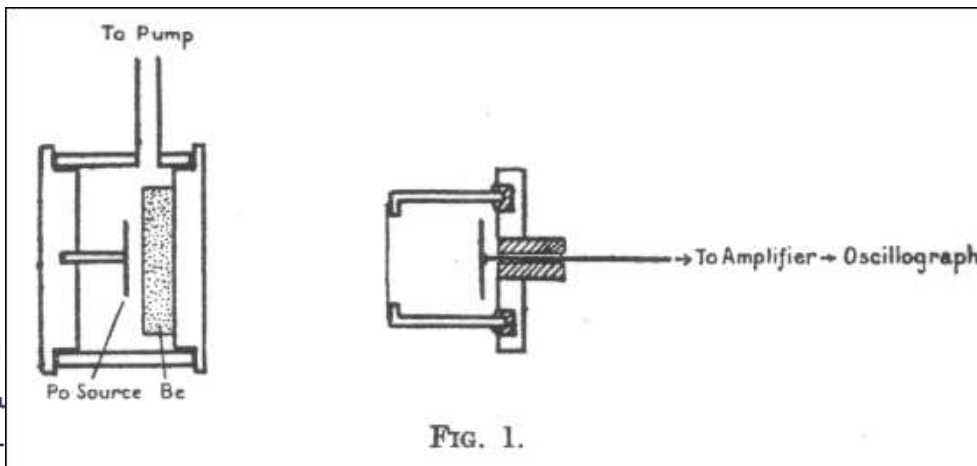

# James Chadwick and Leslie Groves



# Louis Alvarez

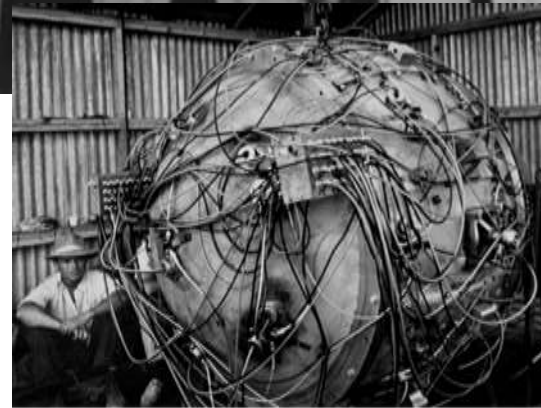

# Radiance from Halcyon

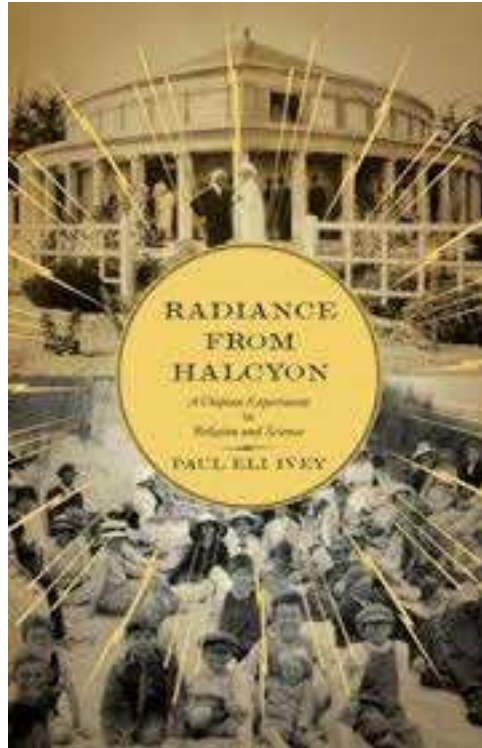

1937



# Round and round we go... Cyclotrons (protons)

Ernest O. Lawrence,  
Milton Livingston

$$f = \frac{qB}{2\pi\gamma m_0}$$

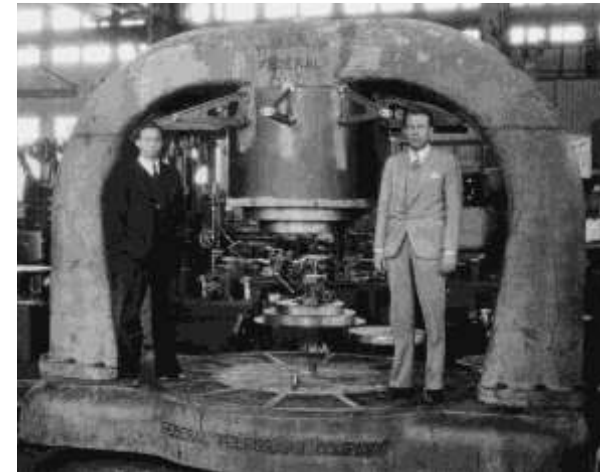
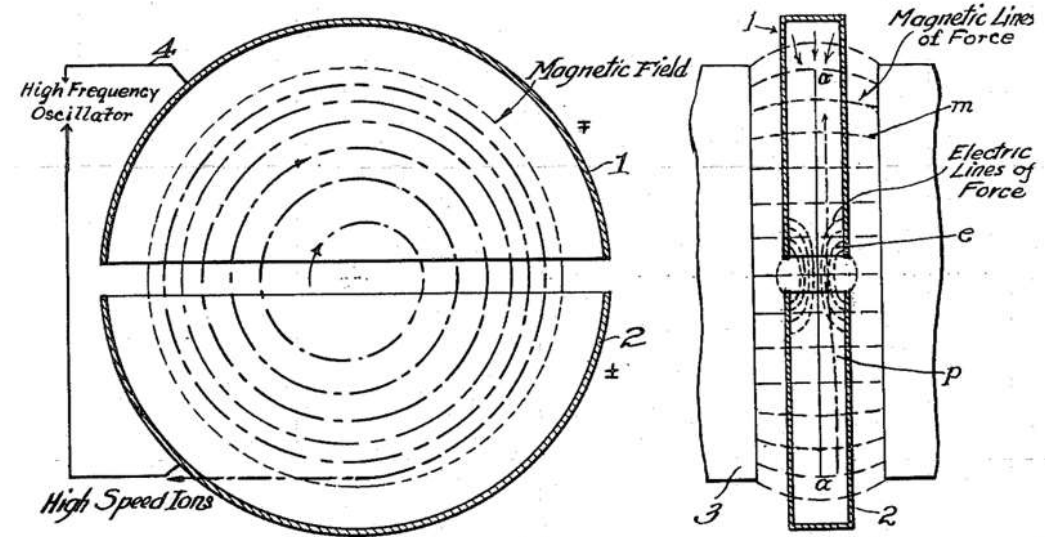

*'Lawrence got his Nobel Prize. I just got a PhD.'  
(but in 8 months)*

# Emilio Segrè and the 37-inch cyclotron deflector foil



*'In February 1937 I received a letter from Lawrence containing more radioactive stuff. In particular, it contained a molybdenum foil that had been part of the cyclotron's deflector. I suspected at once that it might contain element 43. The simple reason was that deuteron bombardment of molybdenum should give isotopes of element 43 through well-established nuclear reactions. My sample, the molybdenum deflector lip, had certainly been intensely bombarded with deuterons, and I noted that one of its faces was much more radioactive than the other. I then dissolved only the material of the active face, in this way achieving a first important concentration of the activity.'*

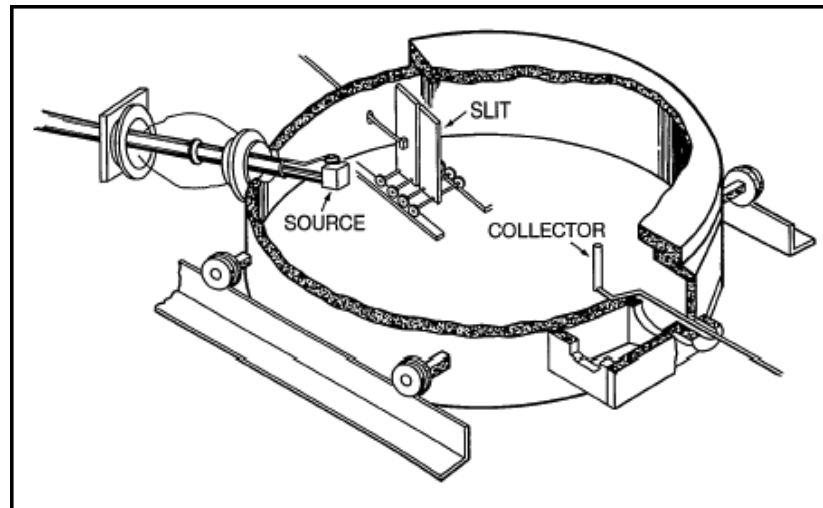

THE E M METHOD OF SEPARATING  
THE COMPONENTS OF TUBALLOY

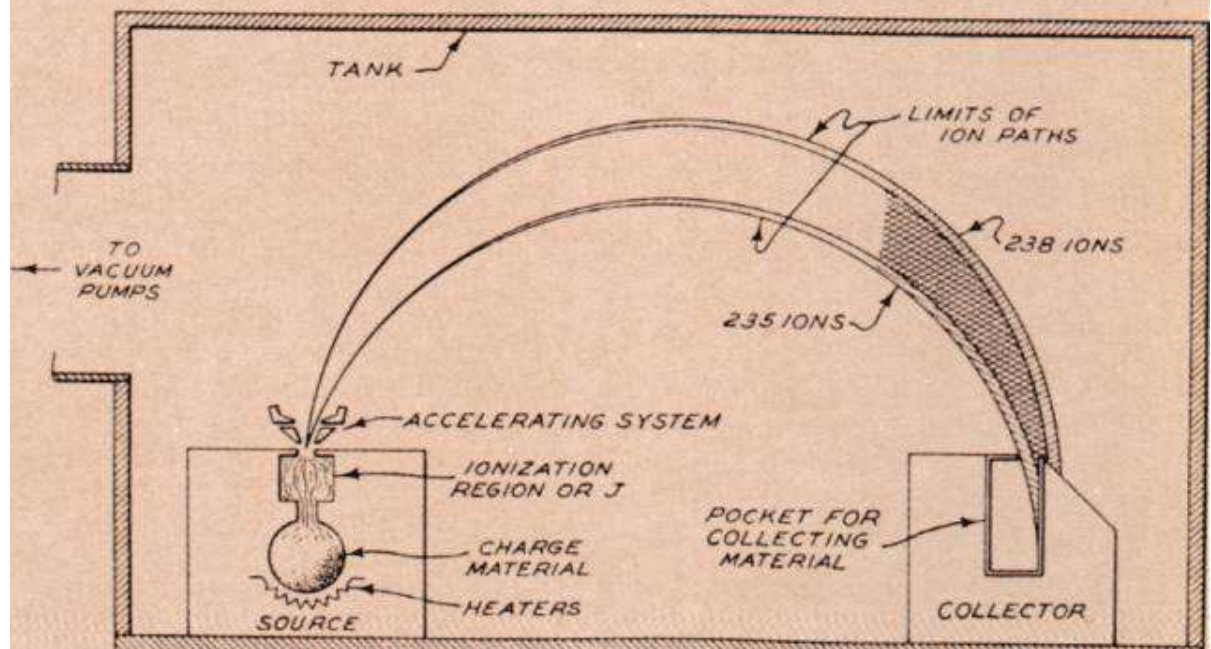
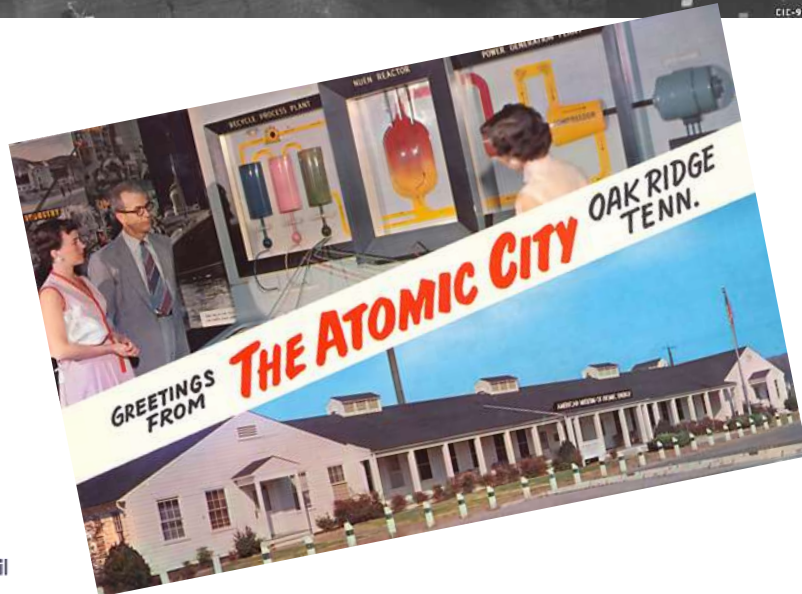
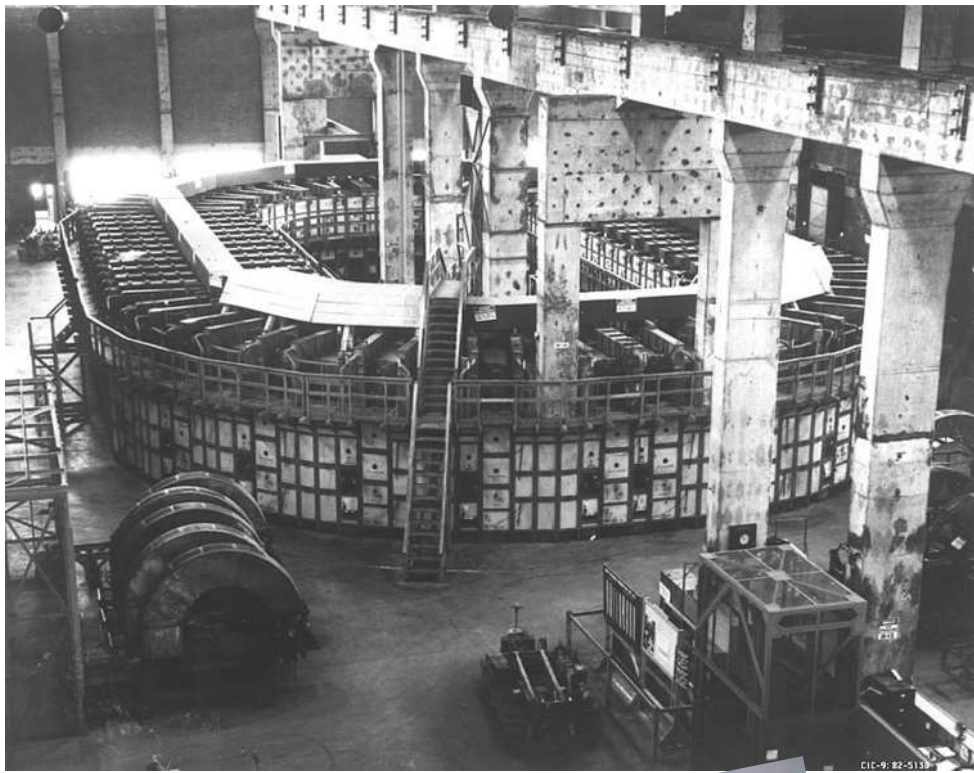

Table II

Balance Sheet of  
Silver Charged to Manhattan District  
(As of Close of Business, 19 December 1943)

	PROGRAM I			PROGRAM II		
	Airdep's Pounds and Ounces			Airdep's Pounds and Ounces		
	Silver Recd. or in Stock	Silver Shipt. or in Stock	Apparent Diff. Gain (G) Loss (L)	Silver Recd. or in Stock	Silver Shipt. or in Stock	Apparent Diff. Gain (G) Loss (L)
<b>1. U.S.M.R. Co., Carteret, N.J.</b>						
a-1 From West Pt., N.J., and by transfer from Treas. Dept. to Manh. Dist of U.S.M.R. Co., Carteret, N.J.	12593332-0 (1)(a)			9253127-0 (1)(a)		
b-1 Returned for reworking from P.D. Co.	1220783-0 (1)			199127-0 (1)		
a-2 Billets shipped to P.D. Co., Bayway, N.J.		13598455-0 (1)			2893235-0 (2)	
b-2 Silver in stock		266237-0 (1)			6557019-0 (2)(a)	
†	13814615-0	13814674 0	(6) 79-0	9447259-0	9447259-0	000-0
<b>2. P.D. Co., Bayway, N.J.</b>						
a-1 Billets received from U.S.M.R. Co.	13598455-0 (1)			2893235-0 (2)(1)		
a-2 Silver in stock		000-0 (1)			1585793-14 (4)	
b-2 Flat silver wire coils shipped to A.C. Co., Milwaukee		12182506-14 (1)			1112878-13 (4)	
c-2 Busbar shipped to C.E.W., Oak Ridge, Tenn.		148489-1 (1)			000-0	
d-2 Returned to U.S.M.R. Co. for reworking		1220783-0 (1)			199127-0 (2)(1)	
†	13598455-0	13551778-15	(6) 3323-15	2893235-0	2892919-11	(4) 315-5(1)
<b>3. A.C. Co., Milwaukee, Wis.</b>						
a-1 Flat silver wire coils recd from P.D. Co., Bayway, N.J.	12182506-14 (1)			1112878-13 (4)		
b-1 In reactors returned from C.E.W.	000-0			39870-3 (4)		
c-2 In reactors shipped to C.E.W.		11743313-11 (1)(1)			000-0	
b-2 Silver in stock, f.s. wire coils		420518-3 (1)			1112861-6	
c-2 Silver in stock, scrap and dust		1137242 (1)			18-15 (4)	
d-2 Silver in stock, dust		<del>1137242 (1)</del>			<del>18-15 (4)</del>	
e-2 Silver in stock, in reactors ret'd from C.E.W.		000-0			39870-3 (4)	
†	12182506-14	12175224-10	(4) 7282-4	1152769-0	1152750-8	(4) 18-8
<b>4. Custom Engineer Works, Oak Ridge, Tenn.</b>						
a-1 In reactors received from A.C. Co., Milwaukee	11743313-11	11703443-8		000-0	000-0	
b-1 Busbar received from P.D. Co., Bayway, N.J.	148489-1	148489-1		000-0	000-0	
a-2 In reactors returned to A.C. Co.	11891802-12	11891802-12	000-0	000-0	000-0	000-0
†						
-	Apparent Weight Difference, Program I and II			(4) 3879-5		
-	Total Apparent Weight Difference, Program I and Program II			(4) 9215-2		

It should be remembered in reviewing the above tabulation; (1) That U.S.M.R. Co. furnace and stack losses from Program I do not appear inasmuch as the P.D. Co. reportedly returned, in billet form, all silver received from the Manhattan District for melting purposes, when stock and furnace losses are determined the Manhattan District will be under obligation to make good its proportionate share of them. (2) That furnace charge for Program II (included in U.S.M.R. Co. Item b-2 for Program II) is estimated only and could not be determined exactly without shutting down and dismantling the furnace, crushing and assaying the furnace firebrick and contents of the furnace.



# Arthur Dooley: 'Splitting the Atom' (1974)



# 60-inch cyclotron

20 MeV, 1939

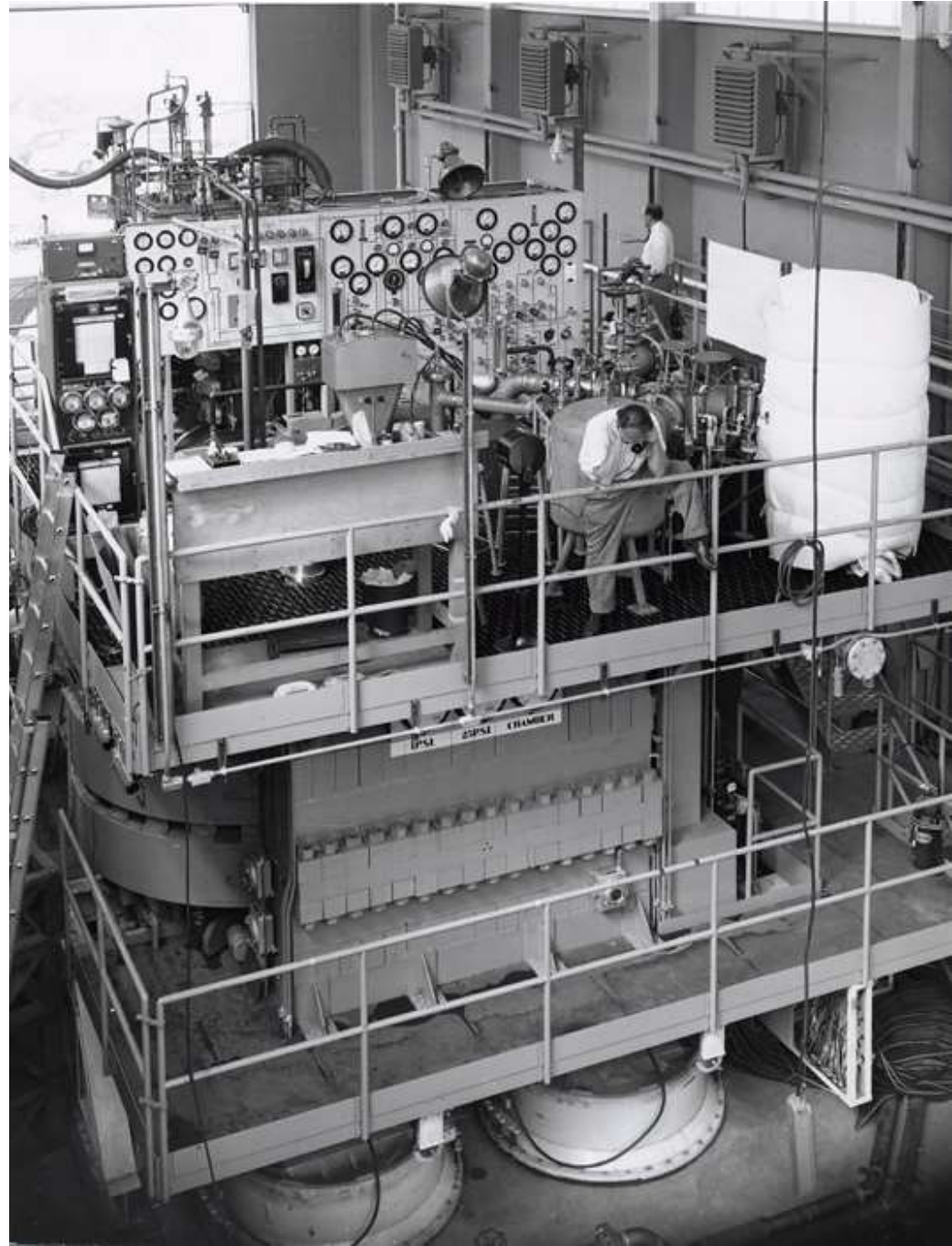

# 'Big Science' and Ernest Lawrence



- LANL
- LLNL
- LBNL
- Oak Ridge (calutron)



# The Betatron (electrons)

Oct. 11, 1927. J. SLEPIAN 1,645,304  
X-RAY TUBE  
Filed April 1, 1922 2 Sheets-Sheet 2

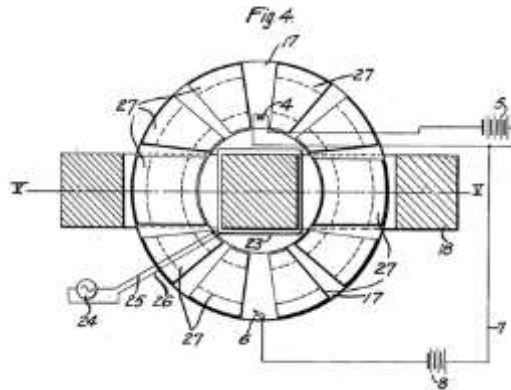

Slepian, 1922  
Wideroe, 1928  
Kerst, 1940



FIG. 14 Diagram of betatron magnet pole tips and vacuum chamber, showing orbit location and the central core supplying flux linkage for acceleration. (From M. S. Livingston and J. P. Blewett, "Particle Accelerators," 1962. Reprinted by permission of McGraw-Hill Book Company.)

Meanwhile, Kerst returned to the University of Illinois to build first an 80-MeV "model" (61) and ultimately a 300-MeV betatron (62) which was the largest and probably the last of this line.

It seems clear that the complete stability theory of Kerst and Serber and the careful and thorough magnet design calculations of Kerst were the reason for Kerst's success in the rapid development of the betatron. Orbital stability requires spatial focusing for particles which deviate in direction from the equilibrium orbit. Such stability will occur in a radially decreasing magnetic field, such as would be specified by a radial variation



2 MeV betatron, Donald Kerst

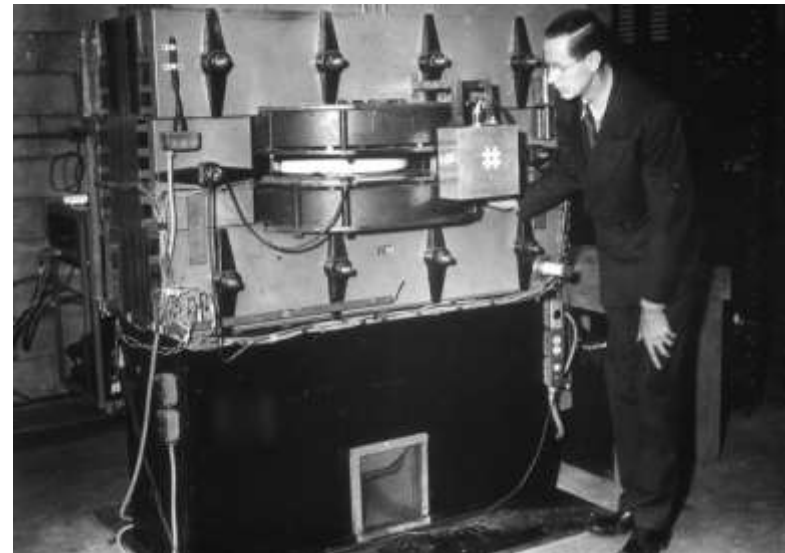

22 MeV betatron

# Electron Betatrons...



# Electron FFAG, with Chandrasekhar and Bohr

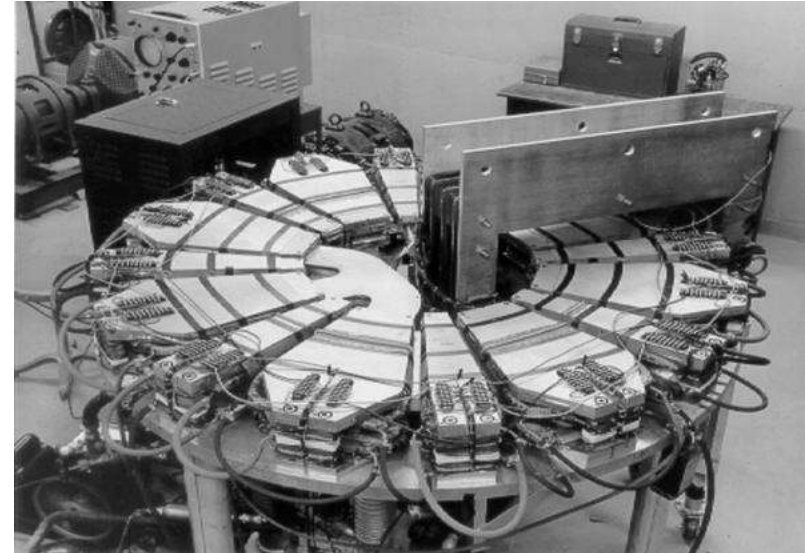

Kerst proposed in 1956 to have colliding beams

# The earliest synchrotrons

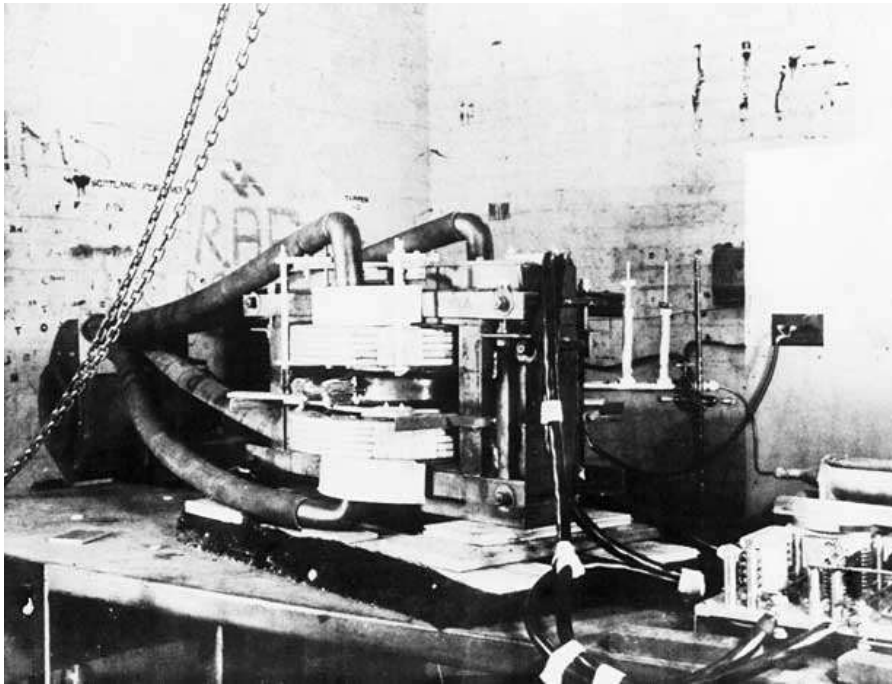

Goward & Barnes's original e- synchrotron  
(converted from betatron)  
Woolwich Arsenal, London, 1946

# Phase stability



Marcus Oliphant

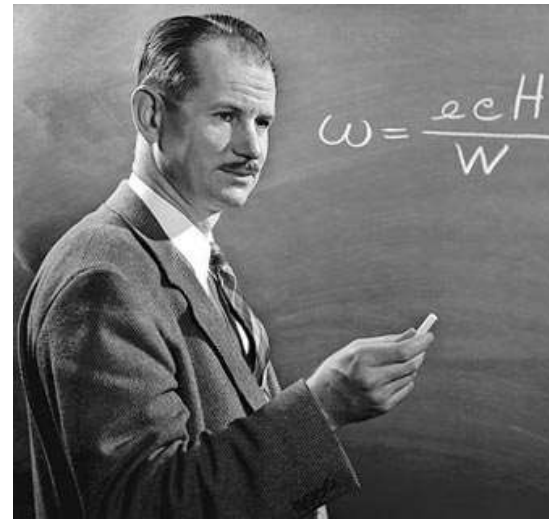

Ed McMillan

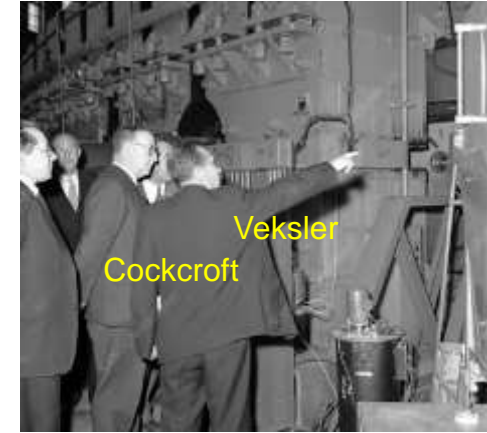

Vladimir Veksler

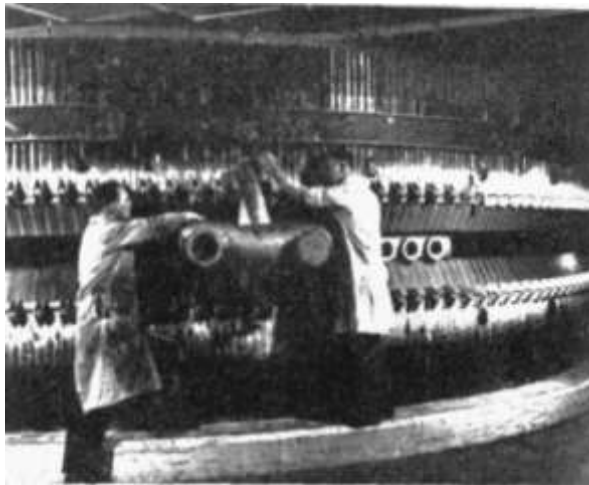

Fig. 12. Birmingham synchrotron magnet with a section of the vacuum chamber and portion of the pumping manifold in place



Synchrotron, Dubna, 1957

First planned proton synchrotron  
1.3 GeV Birmingham, 1953

# Glasgow 350 MeV e- Synchrotron – 1<sup>st</sup> in Europe (1954)

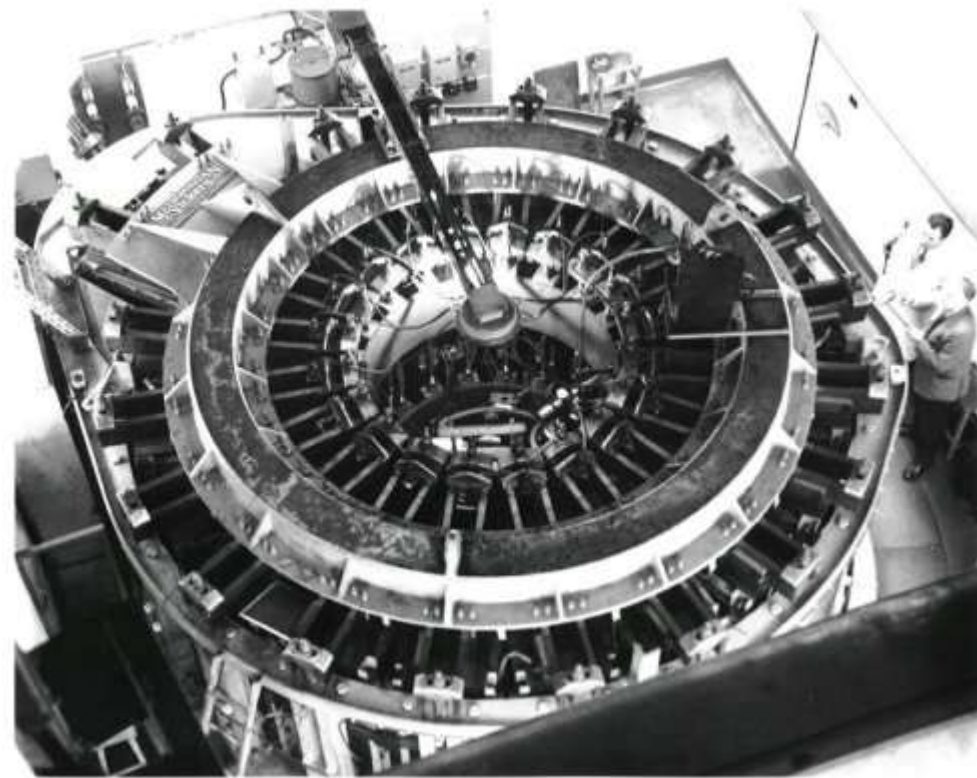

# Cosmotron – first GeV proton accelerator, 1953 (3 GeV)

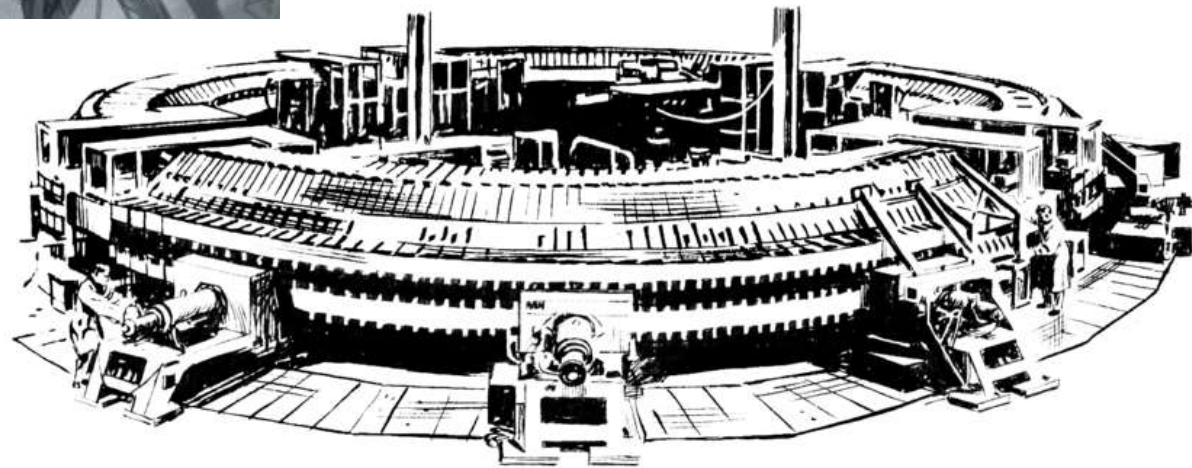

# The Bevatron (6 GeV): a Large Weak-Focusing Synchrotron (1954)



(Ed McMillan on the left)

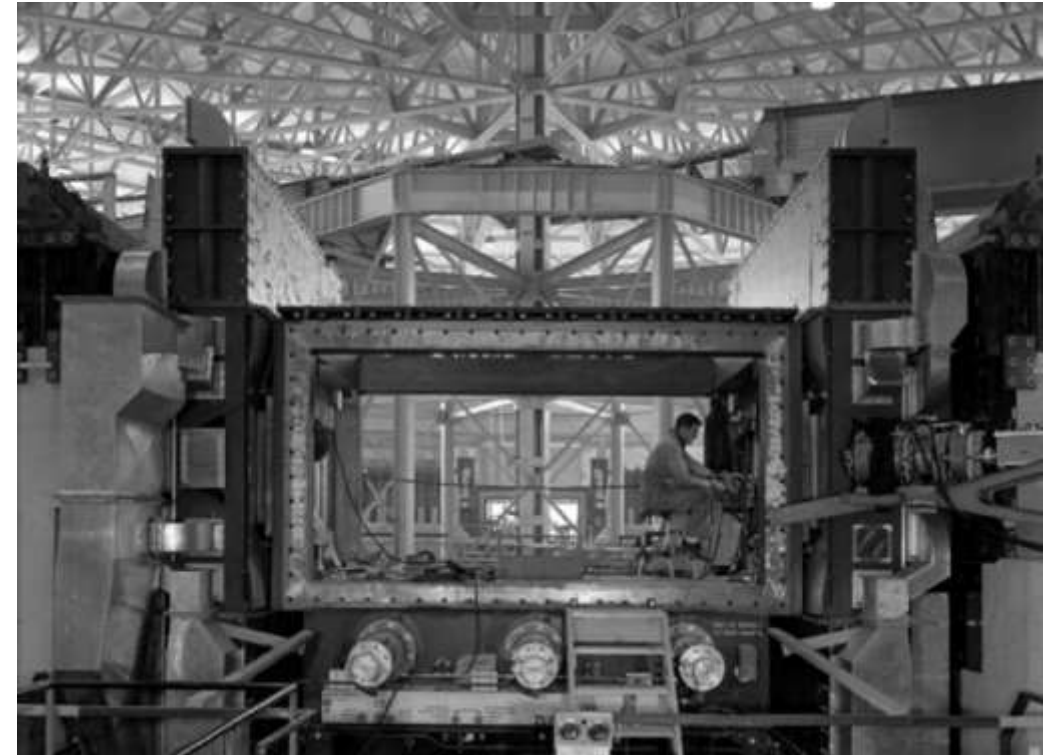
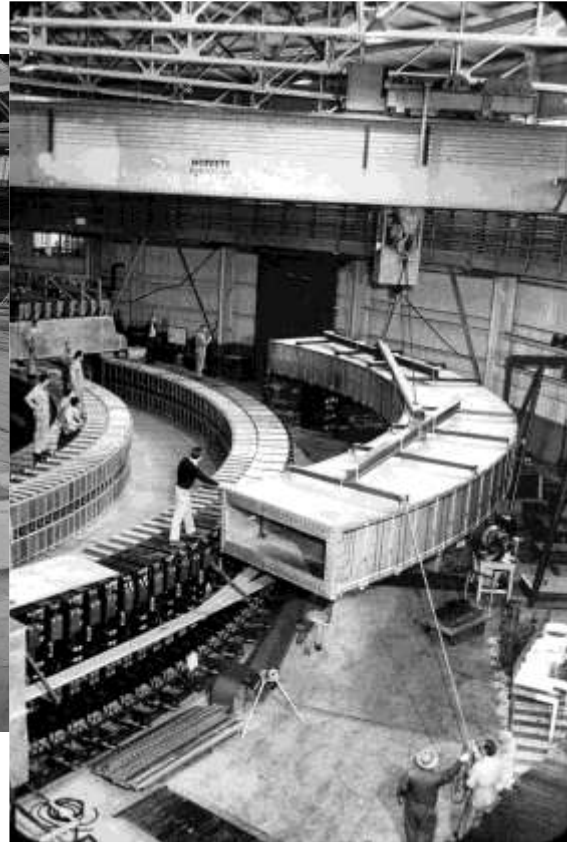

Discovered the antiproton (Chamberlain, 1955)



# NIMROD (RAL, UK): $p^+$ , 7 GeV, 1960

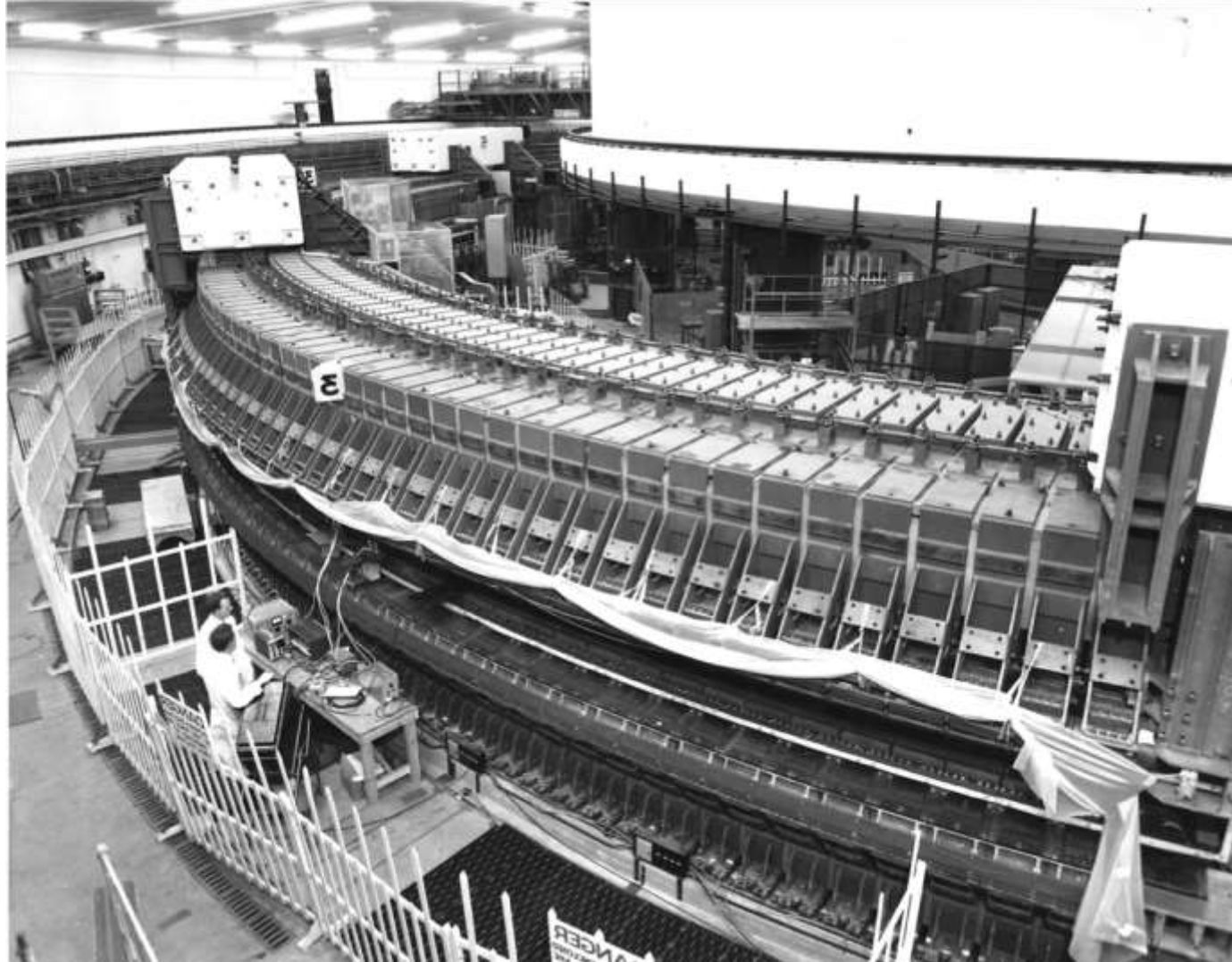

# Before Daresbury, 1964



# NINA at Daresbury Laboratory; e-, 5 GeV, 1966



# The founding of Daresbury



## ATOM LAB. IS A 'WORLD-BEATER' Startling—but safe

DARESBUURY may soon become a famous centre for atomic research. The £3,500,000 nuclear physics laboratory to be built there—if planning permission is granted—will keep Britain in the forefront of world developments.

Director of the project, Professor A. W. Merrison, of Liverpool University, said this week that the Russians, America and West Germany had similar projects.

The laboratory will be a Mecca for research physicists from many British universities, although Liverpool, Manchester and Glasgow are the chief sponsors.

After investigation of several sites, Professor Merrison has already applied for planning permission, and he will give details to representatives of the County Planning Department, and Runcorn Rural Council (Daresbury is in its area), at a meeting on Thursday.

The sandstone at Daresbury was found suitable by boring as a steady base for the delicate instruments of the "lab".

Villagers' fears that a dangerous "atom factory" was to be built, are groundless, Professor Merrison revealed.

The 4,000 electron-volt synchrotron, enclosed in a 200 feet diameter concrete shell, which will be the heart of the laboratory, will be harmless.

### No atom action

"There will be no question of atomic reaction. This is an electrical machine for speeding electrons to high velocity," he said.

"This will enable us to examine

the fundamental structure of matter on a *millionth* of the atomic scale."

The scientists will be able to examine the *twenty millionth millionth* part of an inch.

The accelerator will probe the behaviour of the tiniest particles known to science by speeding up the same kind of electron beam which throws the picture on a TV set.

Although this is a research project, the possible findings could be the basis for great future developments—in space travel, for example.

The project was authorised by the Ministry of Science in July. If planning permission is granted, building will start next spring, and completion is envisaged after five years, although the laboratory would be in operation before that.

There would eventually be a staff of 250; local people would be employed.

Professor Merrison, 38, is a Londoner, but has been at Liverpool for some years. Earlier he studied in Geneva.

# Strong Focusing



Ernest Courant, Milton Livingston,  
Hartland Snyder, John Blewett

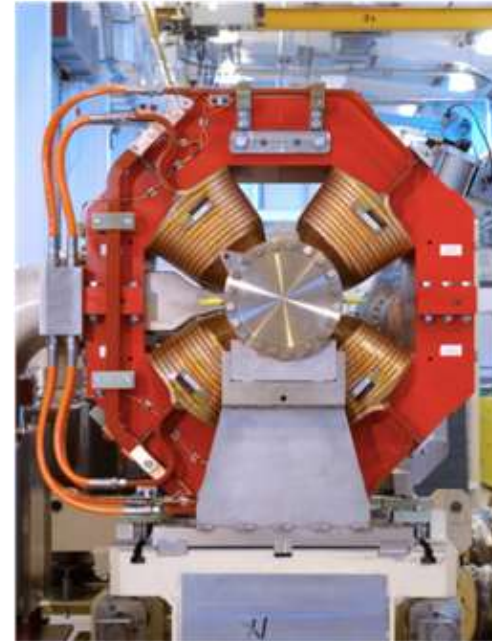

Feb. 28, 1956 2,736,799  
 NICHOLAS CHRISTOFILOS (OR PHILOS)  
 FOCUSING SYSTEM FOR IONS AND ELECTRONS  
 Filed March 10, 1950 4 Sheets-Sheet 1

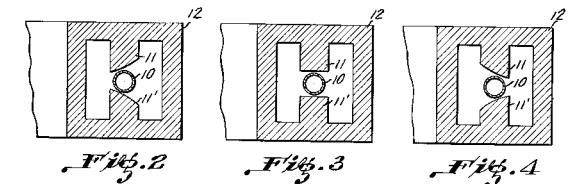
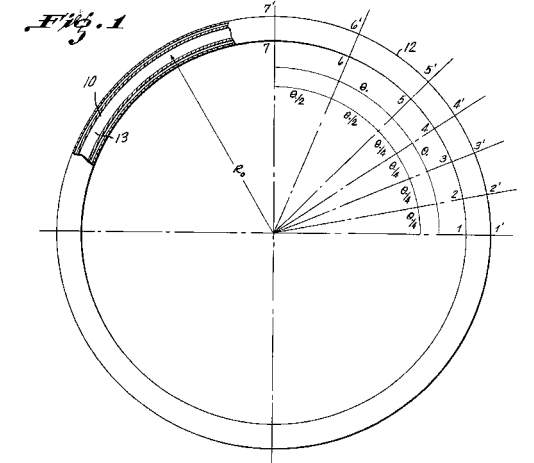

INVENTOR  
 NICHOLAS CHRISTOFILOS (OR PHILOS)  
 BY *Wenderson H. Lewis & Frank*  
 ATTORNEYS

# Nick Christofilos, and Particles in Space



*Starfish Prime (1.4 MT) a.k.a. the 'Rainbow Bomb' - knocked out Ariel 1, the first British satellite, and Telstar 1, the first TV satellite*

..turning the Earth into a giant particle accelerator, to knock out incoming nuclear weapons

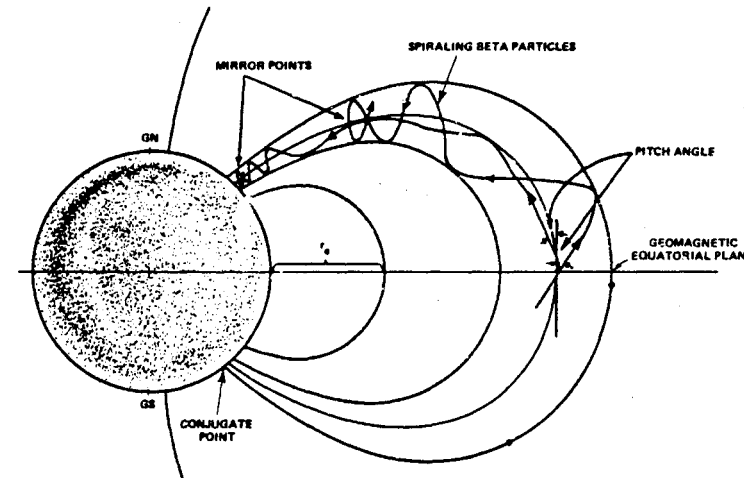
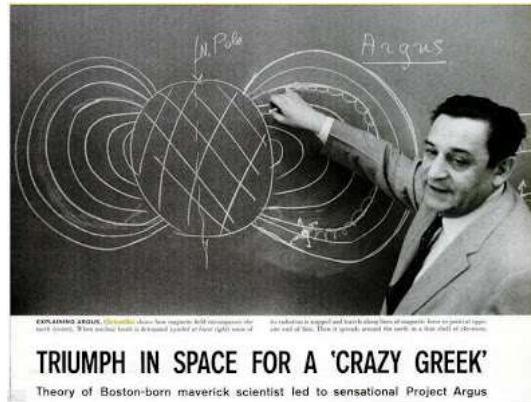

Artificial 'Beta injection' into inner radiation belt; particles remained trapped for 5 years!

# Digging the first foundations for CERN, May 1954







# ADA – the first electron storage ring

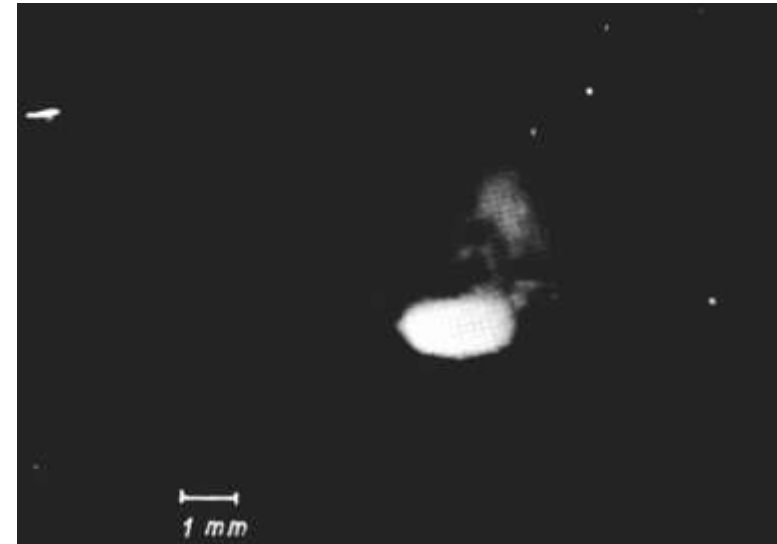
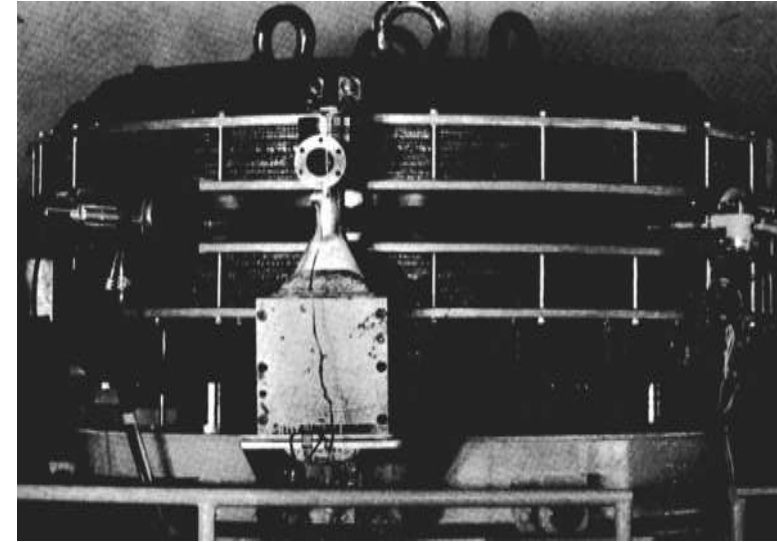
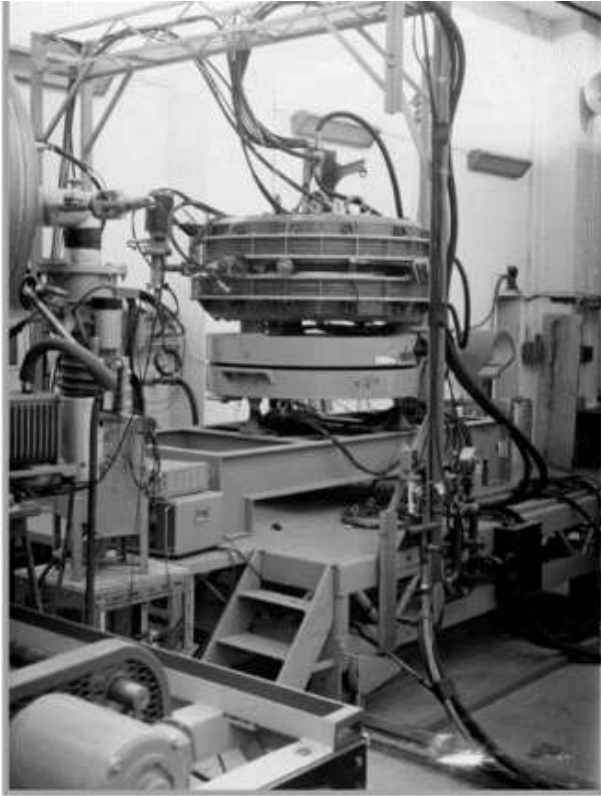
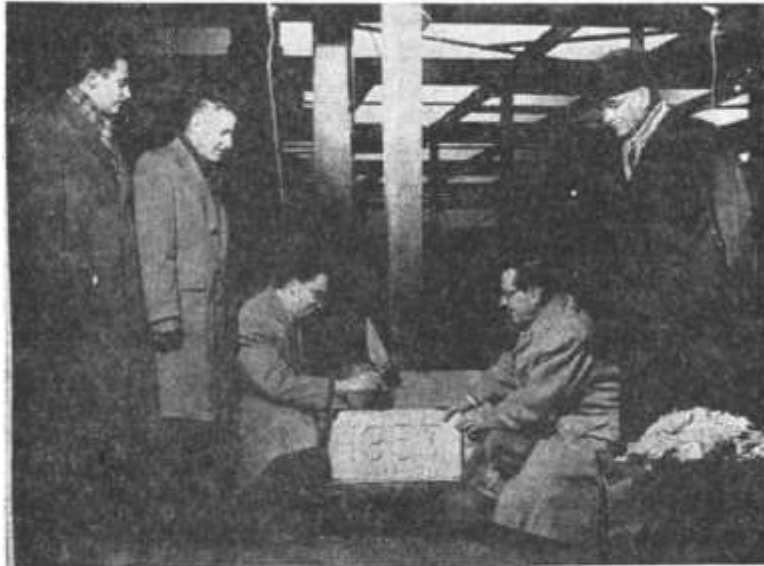

Fig. 2. Left: AdA installed in Salle 500 MeV, Laboratoire de l'Accélérateur Linéaire, Orsay, France. 1963. Right: a drawing by Bruno Touschek reflecting frequent

# Storage Ring Colliders (1963)

Cornerstone of Accelerator Is Laid



FORRESTAL: Milton G. White, director of the Princeton-Penn accelerator, lays cornerstone. Also (l. to r.), designers Gerald K. O'Neil and Frank G. Shoemaker, AEC's Enzi DeRenzi, Alan G. Shenstone '14.

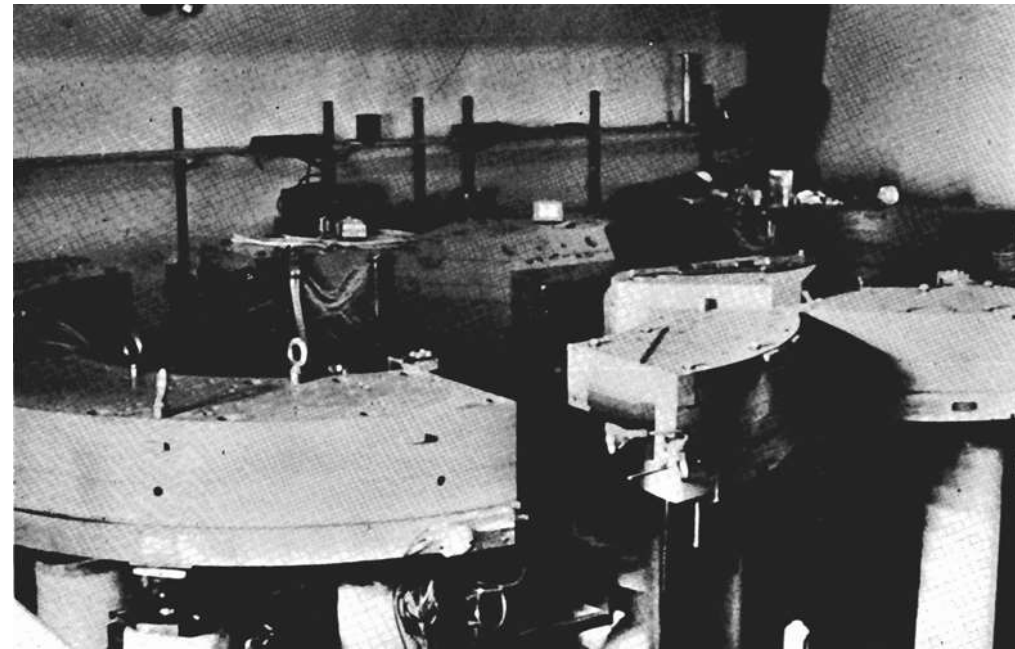
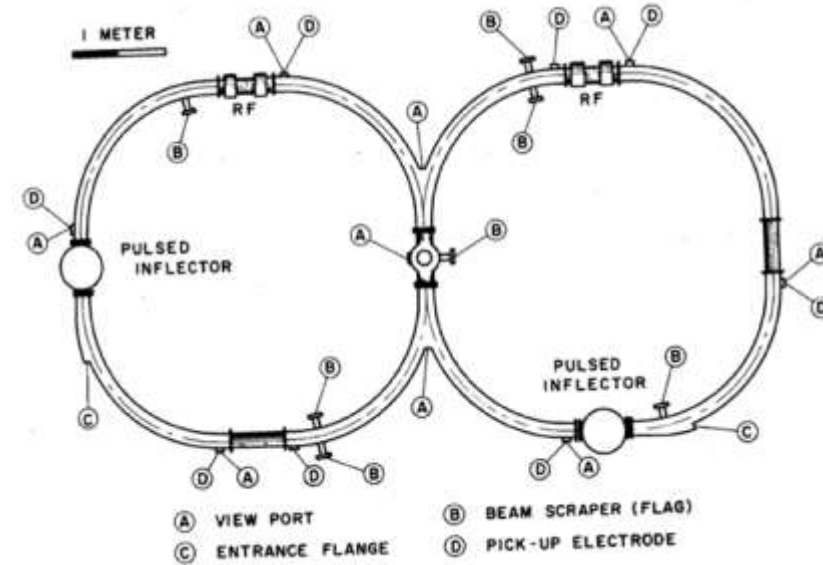

Gerard O'Neil



# Gersh Budker

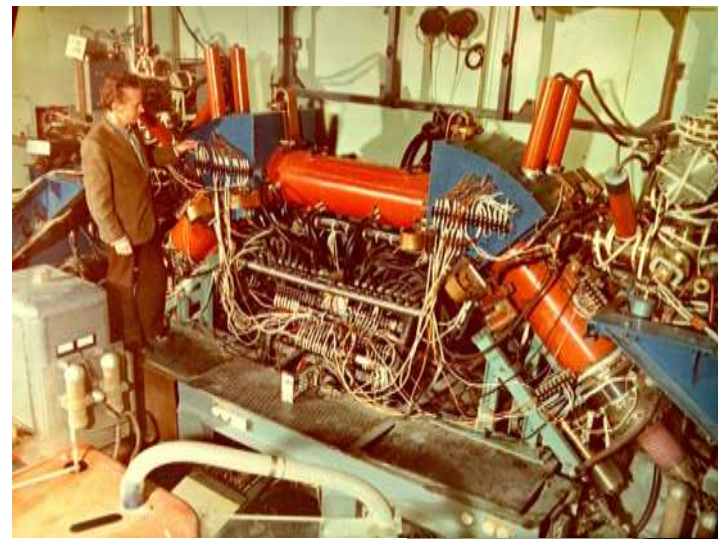
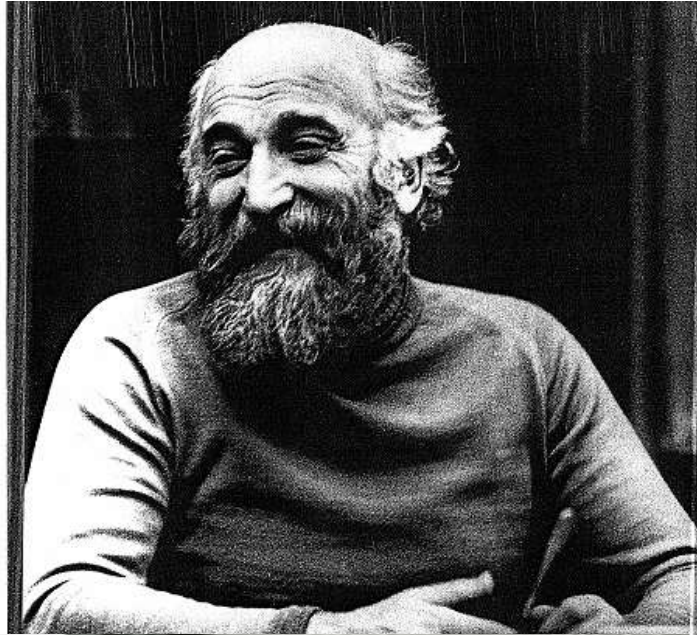

Invented electron cooling  
Founded INP Novosibirsk



with Boris Chirikov



# Stochastic Cooling; Simon van der Meer (1970s)

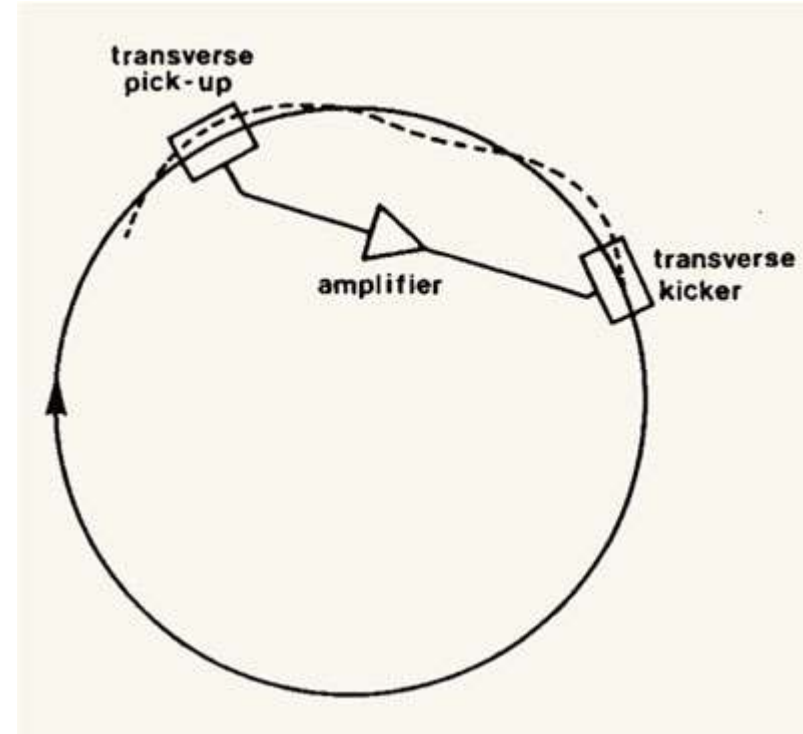

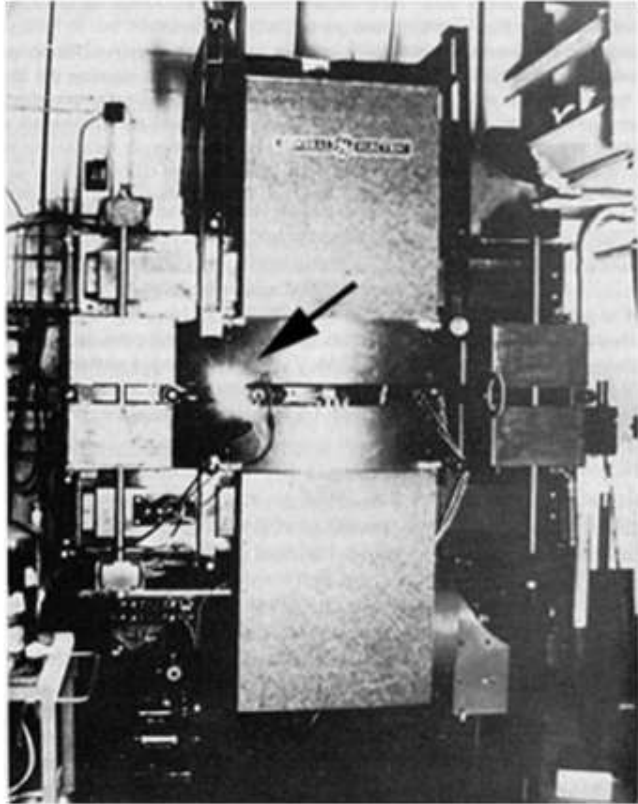

The General Electric Synchrotron

*'If the accelerator tube of the 100-MeV betatron at Schenectady had not been opaque, the visual observation would probably have been made three years earlier by Westendorp or Blewett soon after the publication of your letter to the Physical Review (Phys. Rev. 65:343, 1944). Unfortunately they were not able to see through the silvered wall of the betatron donut.'*

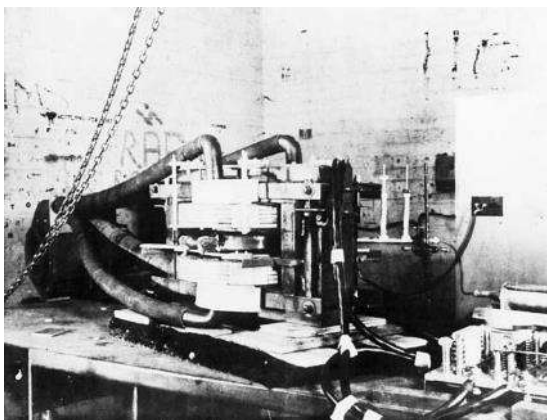

Goward's original synchrotron  
(converted from betatron)  
Woolwich Arsenal, London



# Julian Schwinger and Matthew Sands

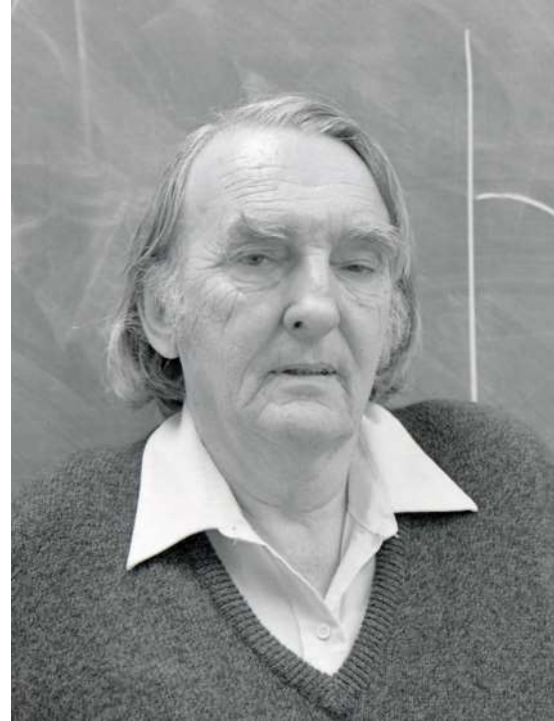
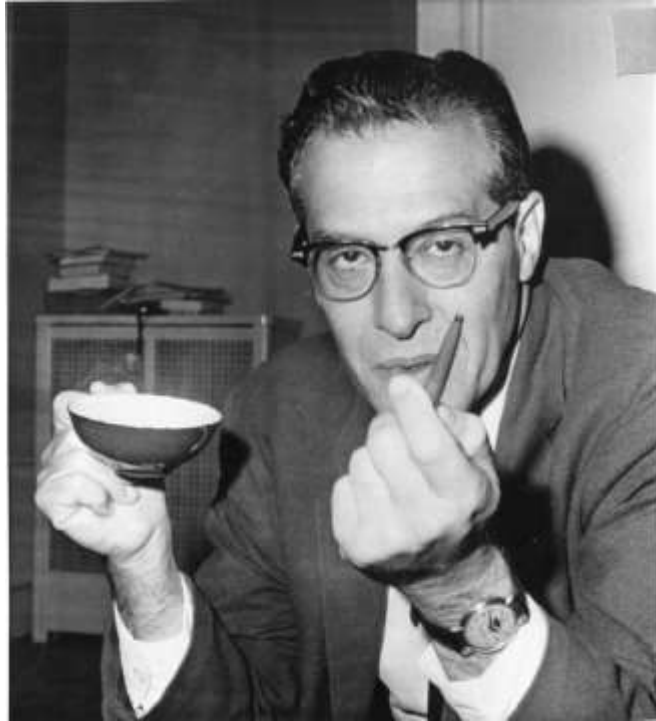

*'My laboratory is my ballpoint pen'*

# The first X-ray beamline – Daresbury, 1970s

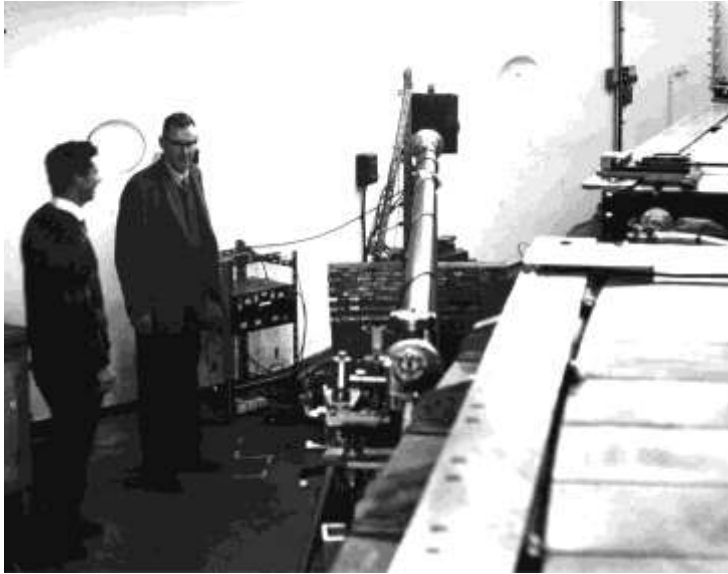

First X-Ray Beamline on NINA



The original synchrotron radiation gang



SRS, Daresbury (1980-2008); world's 1<sup>st</sup> X-ray facility





# Achromats



Renate Chasman  
Phys. Perspect. 10 (2008) 438



## 1. Introduction

The most important factor for synchrotron radiation users is the brilliance which is mainly determined by the cross section of the beam and given by the square root of the emittance multiplied with the betatron function.

The emittance  $\varepsilon$  of a beam in a storage ring is determined by the balance of two competing processes: the quantum excitation by the emission of synchrotron radiation and the acceleration of the particles within the rf cavities. The formulae for calculating the emittance of a storage ring and other related parameters are summarized in table 1.

The emittance scales in general with the square of the energy and the third power of the bending magnet's deflection angle. The optics influences the emittance

For the case in fig. 1b a minimum of  $\beta$  and  $\eta$  in the centre of the magnet is required with  $\beta_{\min} = L/(\sqrt{15})$  and  $\eta_{\min} = L^2/(24\rho)$ :

$$\varepsilon_b = C_q \gamma_0^2 \frac{1}{J_x} \phi^3 \frac{1}{3 \times 4\sqrt{12}}. \quad (2)$$

$\phi$  if the bending angle of the dipole, the other symbols are explained in table 1 [3-5].

The second expression is smaller than the first one by a factor of three. Hence to reach the lowest emittance, a storage ring should have a lattice which provides a shape of the horizontal betatron and dispersion functions as represented in fig. 1b in all dipole magnets. However, other design considerations forbid this. A light source includes undulators and wigglers and at the position of these insertion devices, in the long straight sections, the dispersion has to be zero. This